

Note to parents...

I encouraged all parents to go through these materials alone first in order to get a good understanding of the concepts and just an overall “feel” for what was provided in these pages prior to undertaking these exercises with your children. That way, if a child struggled with a particular section, perhaps you could spend more time on it using additional “blank bubbles” that were provided further in these pages before going on to another topic. “Knowing what you had available”, I believed, would better help you get through these materials and concepts. Any future additions to these materials would be posted along with these current materials under the [Parent Teaching Tools](http://www.autismhelpforyou.com) link on my website: <http://www.autismhelpforyou.com>. There were several other materials already posted there for parents.

I also encouraged you to put your “concept sheets” in plastic cover sheets in a binder. These were actual sheets I used with Zachary in helping him to understand “how” language worked and were pages I was sure, parents would find themselves using, perhaps several times. Printing the same pages over and over again could get expensive rather fast, especially since many of these pages had a tremendous amount of color.

I chose to use a lot of color in these materials in order to help facilitate comprehension. However, parents who did not have a color printer or who chose to print in black and white for cost reasons would also be able to use these materials because, in addition to color variations, I was careful to include “shape variations”, too. I possible, however, **I did strongly encourage you to print these materials in color because I very much suspected color played a huge role in the world of children with autism.**

When building actual sentences, I chose to put in front of Zachary the “lists” provided herein... the list of pronouns, nouns, adjectives, verbs, adverbs, etc., to allow him to “pick words” from the appropriate lists as we worked on building sentences. This made things easier for Zachary and allowed us to focus on the task at hand with minimal stress. Minimizing stress in Zachary was always something I strived for in compiling materials for him because I wanted him to see learning as “fun” and the more stress, obviously, the less fun. Learning should be fun for all children – including children with autism. I urged all parents to resist the urge to “rush through” these materials. Teaching a concept a day was probably enough. Gauge **your child – and yourself!** When the learning **or** fun is gone, it is probably time to for a break or stop for the day.

Note that I used “green ears” in my materials for listening. Originally, they had been “red”, however, I now knew some discipline programs used “red” and “green” “for acceptable or not” in behavior and as such, I did not want to confuse children or make them think that “red ears” = stop listening given “red” could be associated with “stop” in such programs. Subtle – but, again, potentially – critical!

Finally, you may want to do a “search and replace” to change the name “Zachary” to your child’s name if you have a boy as that would make these exercises “more personal” for your child. If your child is a girl, that will be more difficult to do but you can do it and change the associated pronouns. It will just take a little more work. There are really not that many examples using “Zachary” and so, this is not a huge issue, but one I felt I should raise anyway for those parents who wanted to do that. I encouraged you to graph as many sentences as possible with your child once this concept was learned – from very basic to much more complicated sentences. :o)

Note: Some of these sheets/pages can be copied/printed over and over again and used to provide multiple examples of the same concept. Also, remember to use onomatopoeias and compound words as much as possible. :o)

PRONOUNS...

A pronoun is a word that takes the place of a noun.

A noun is a person, place or thing.

A pronoun provides a “shortcut” for talking...

A pronoun gives an “easier way” or “shorter way” to say something.

“FLIPPING PRONOUNS”...

Some pronouns can only be used to “talk about people” or “take the place of someone’s name”.

The most important pronouns to understand are the flipping pronouns:

I

me

you

These are the “flipping pronouns”!

I, ME and YOU

The “Flipping Pronouns”...

I and **Me** are pronouns used by the person who is **TALKING** to talk about “himself” or “herself” or “myself”.

I = me = person talking

You is a pronoun used by the person talking to talk to or talk about the “other person”.

So “YOU” is the person who is NOT talking.

**You = person listening =
person NOT talking = other person**

**When people talk to one another, they
“take turns” talking... first one person
talks... then, the other person talks...**

The person talking always = I or me

The other person always = you

That’s how “flipping pronouns” work...

They “flip flop” so...

The person talking always = I or me...

and...

The person listening always = you.

person talking =
person saying something =
person with sounds coming
from the mouth

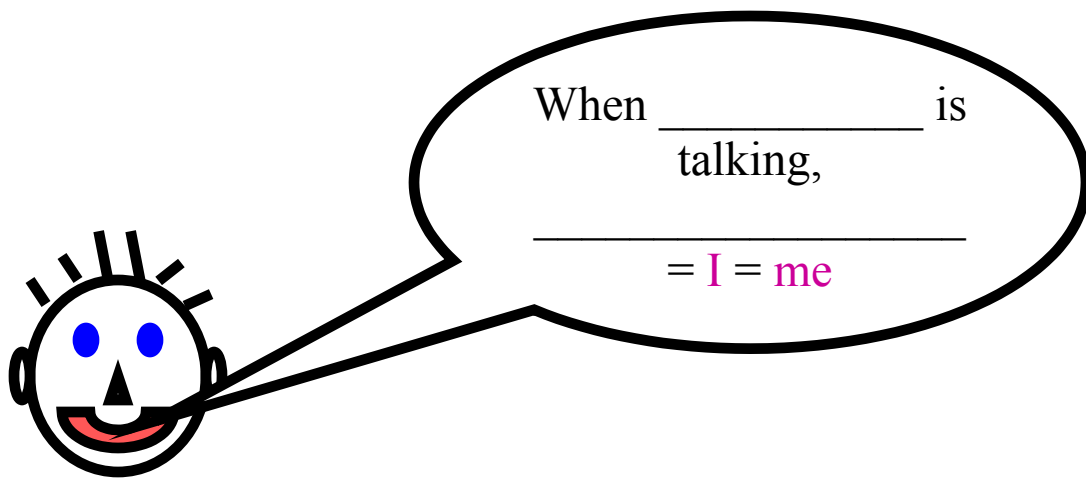

Person talking = **I or me**

Person talking = I or me

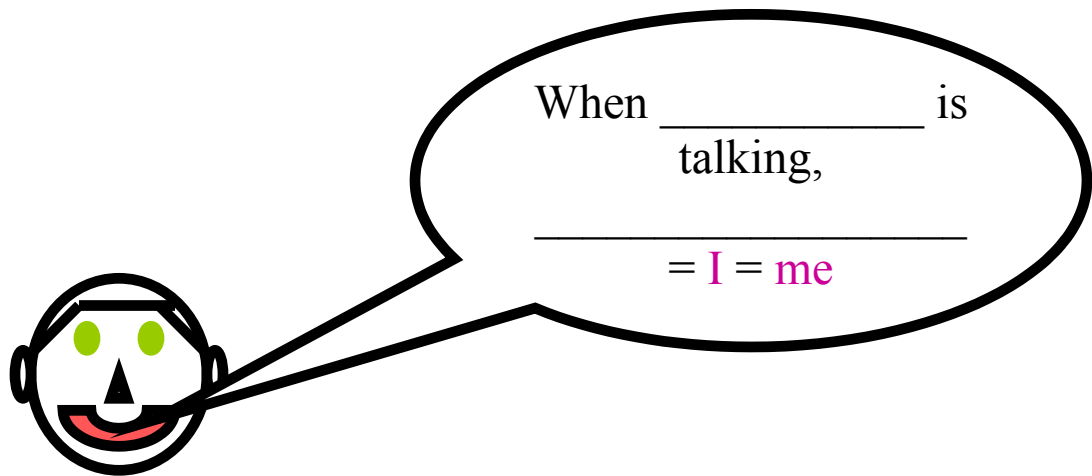

person listening =
person NOT talking =
person with no sounds coming
from the mouth =
person hearing with ears

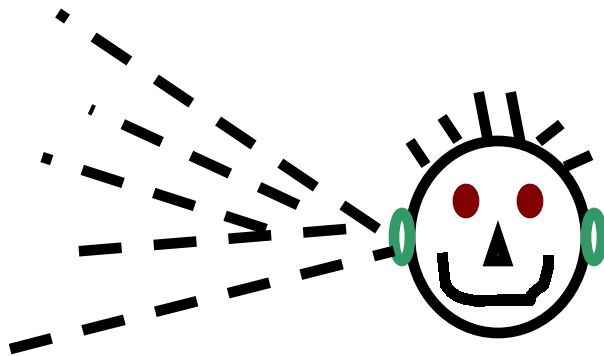

person listening = you

In a conversation, there is always **one person talking** and **one person listening...**

person talking = I or me

person listening = you



person talking =

I = me

person listening =

you

**When one person is all done talking,
then the other person talks...**

So, now, the new person talking

= I or me ...

and...

the new person listening = you...

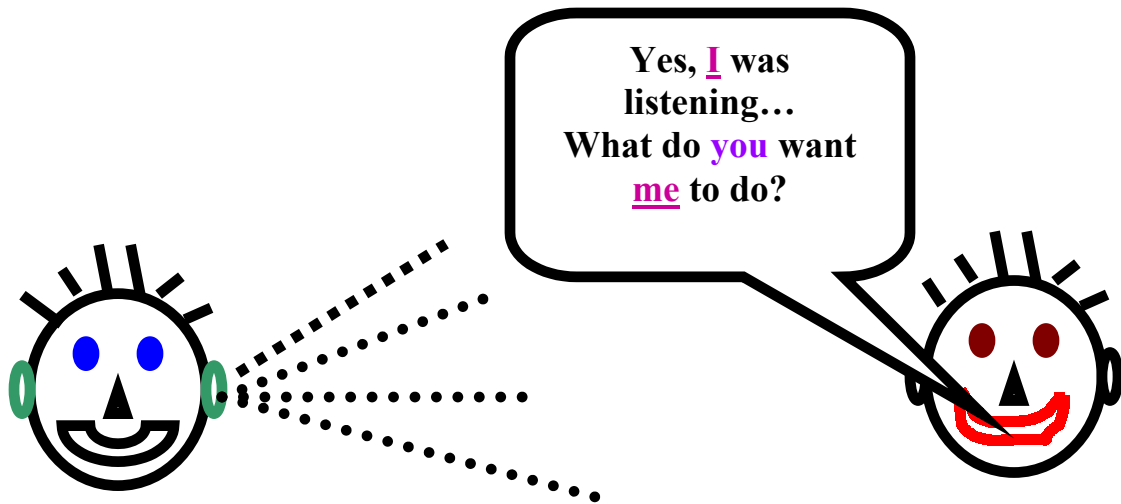

**new person
listening = you**

**new person
talking = I or me**

When the second person is done talking or asking a question, then the other person can talk again...

So, again, they “flip flop” or “switch” and so, the pronouns “I, me” and “you” “flip flop” too because the person talking and the person listening have changed – again...

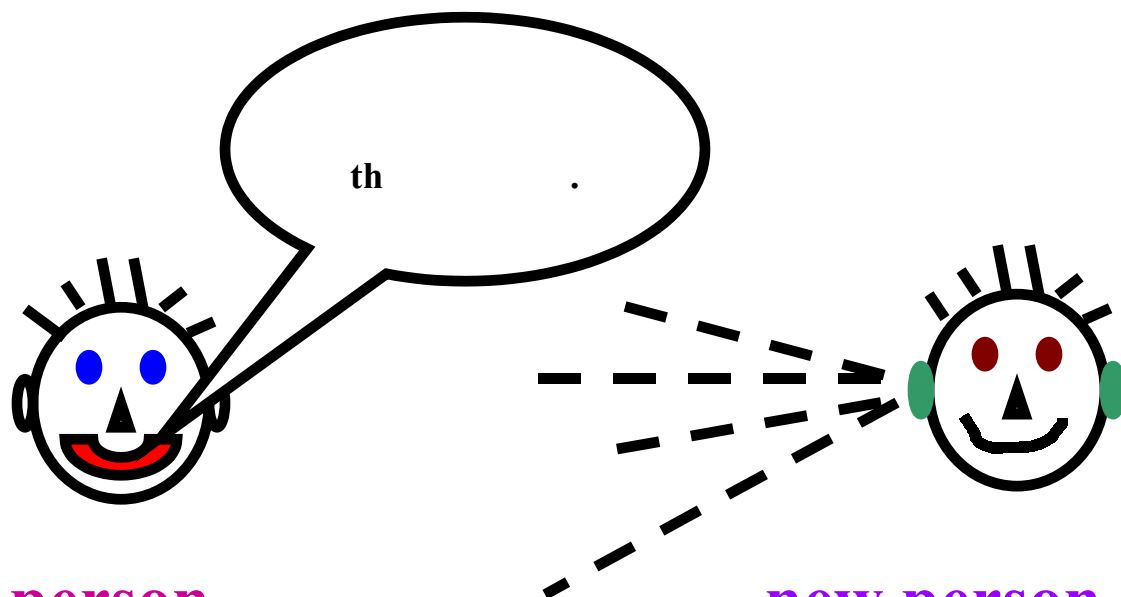

new person
talking = I or me

new person
listening = you

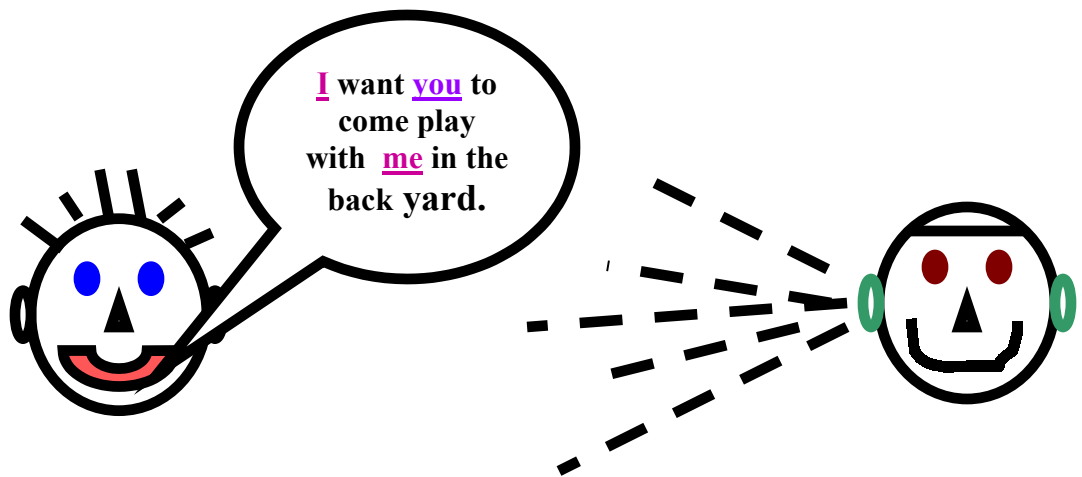
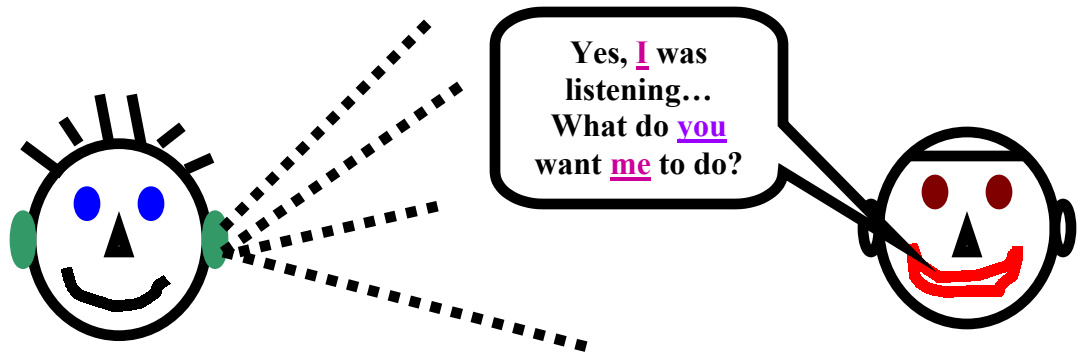
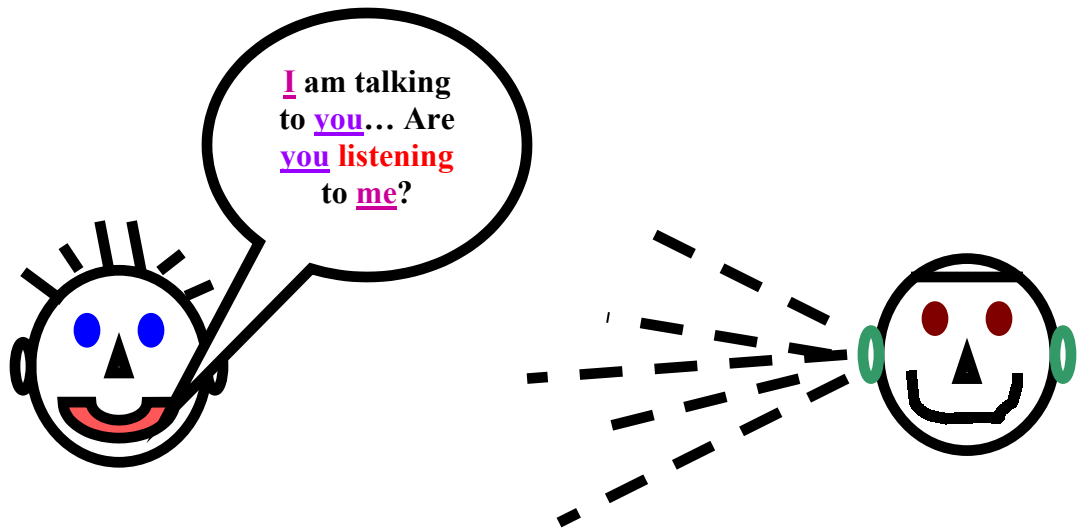

Person talking = I or me
Person listening = you

Person talking =

I = me

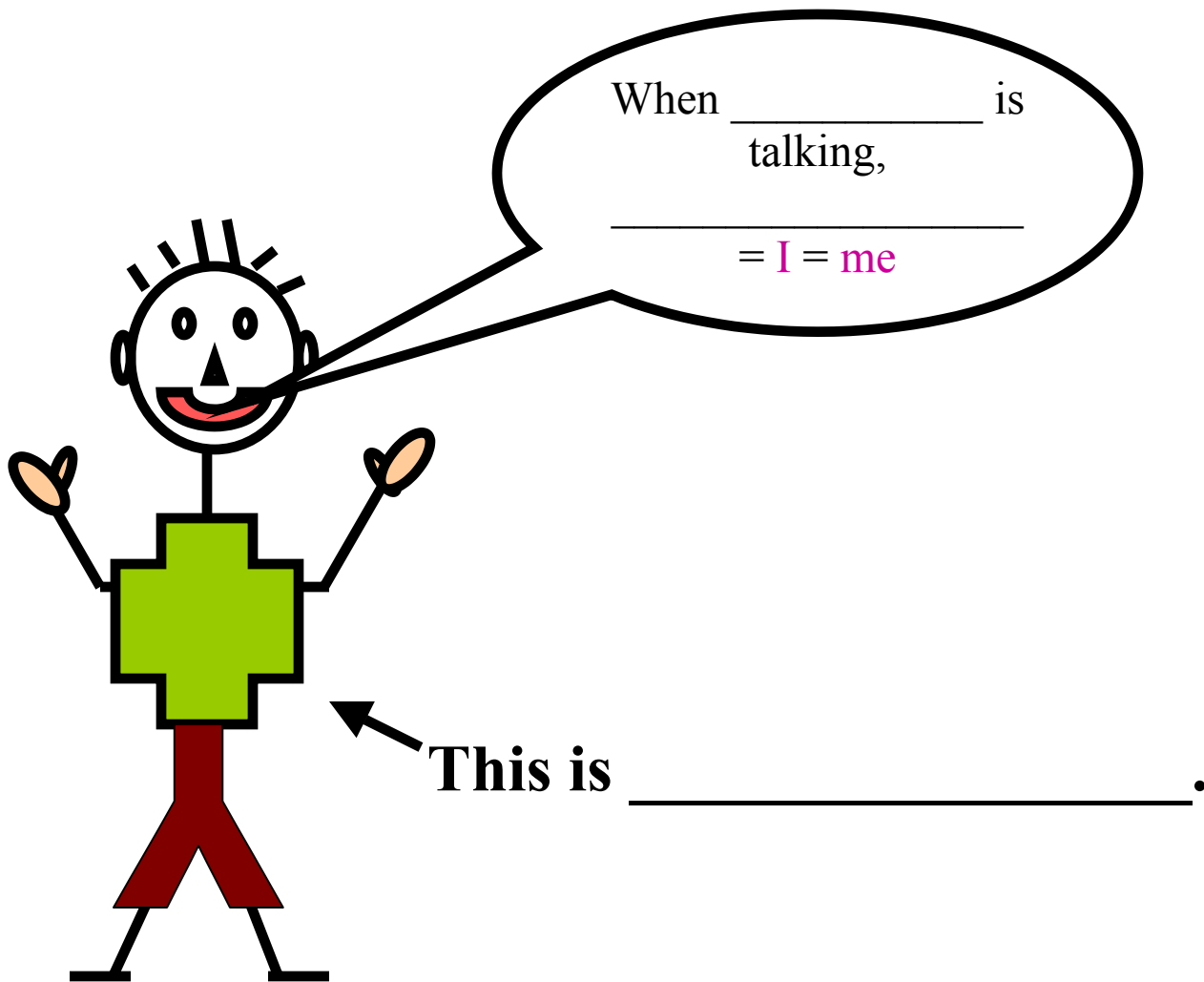

Person talking =

I = me

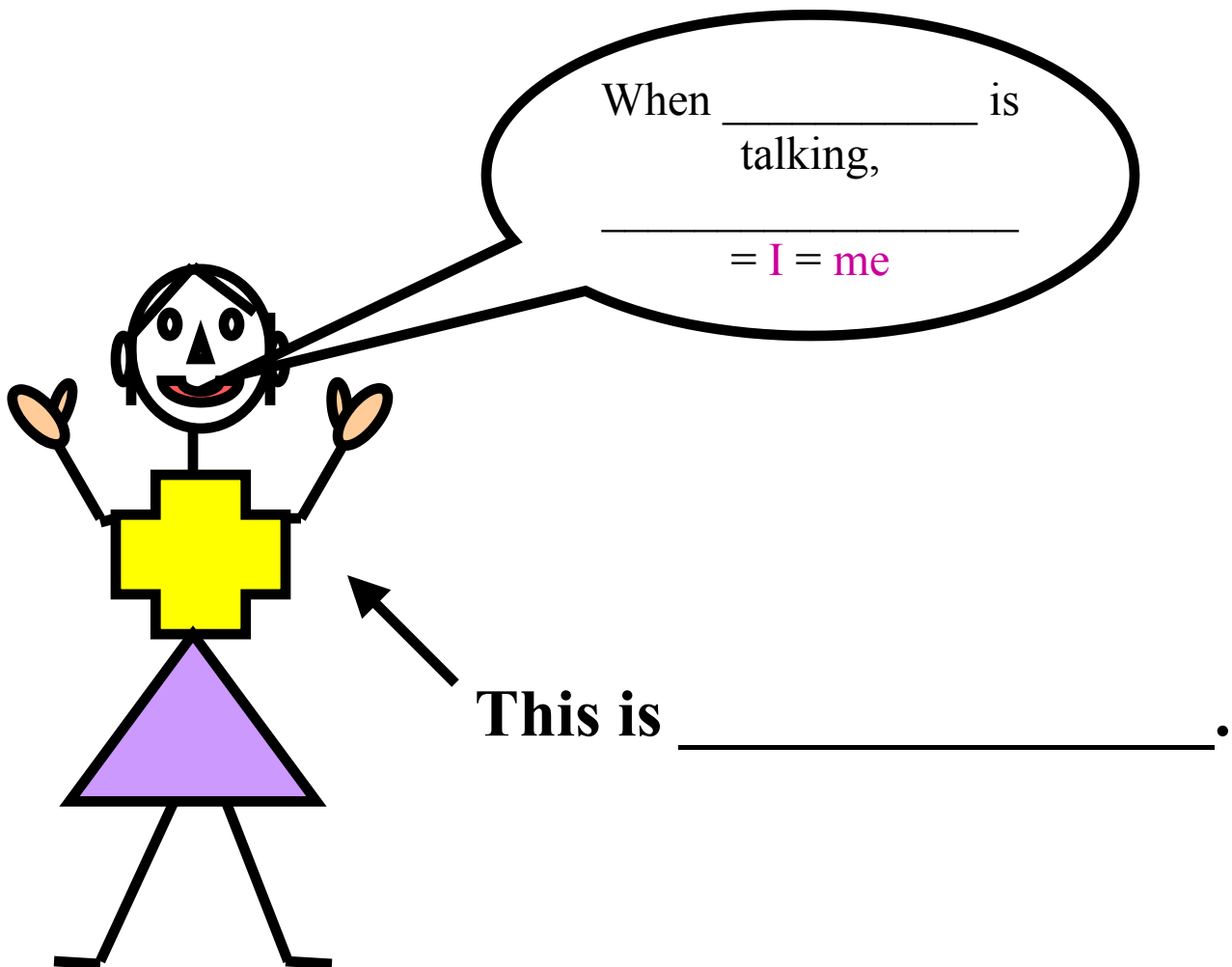

Person talking =

I = me

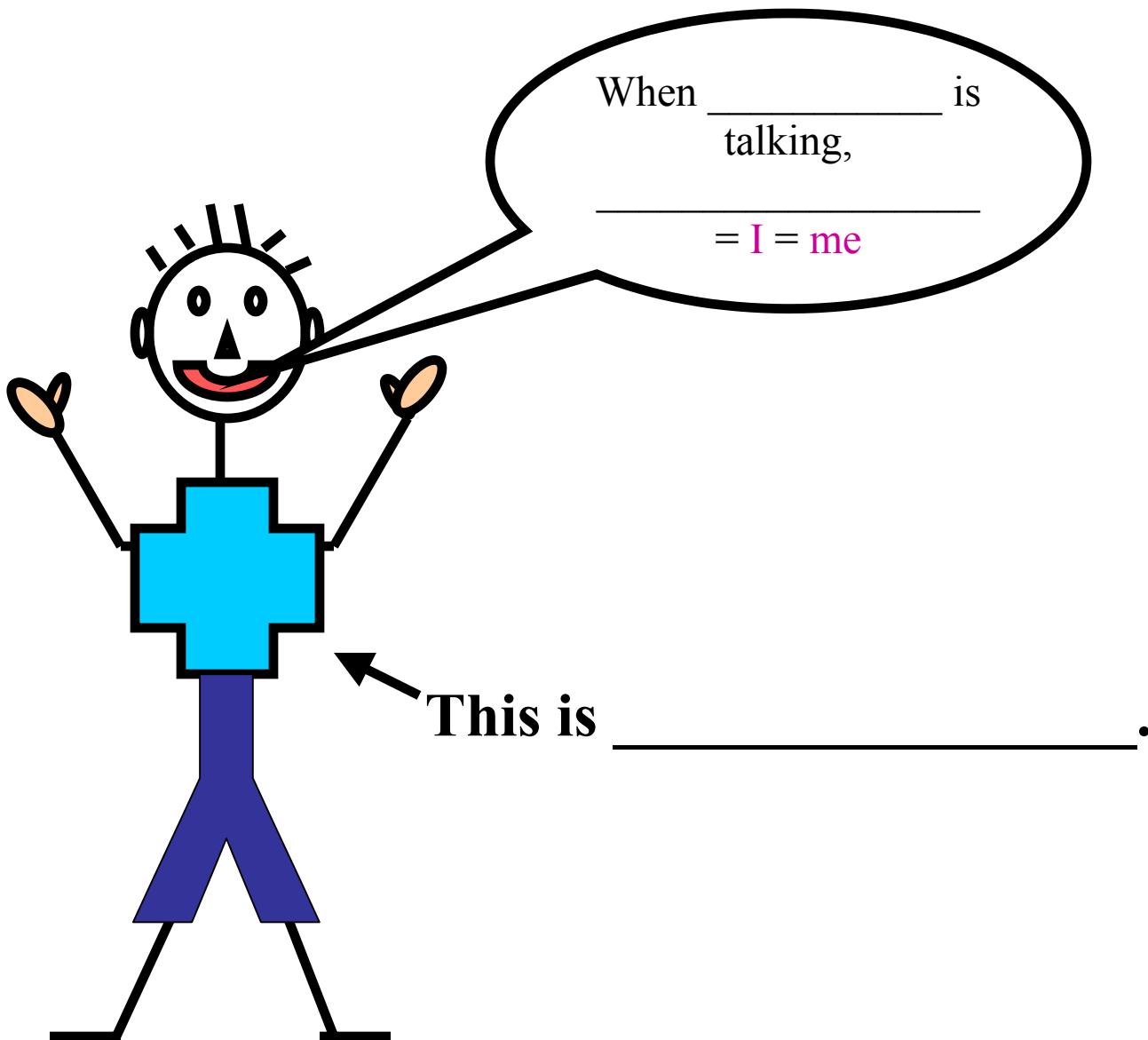

Person talking =

I = me

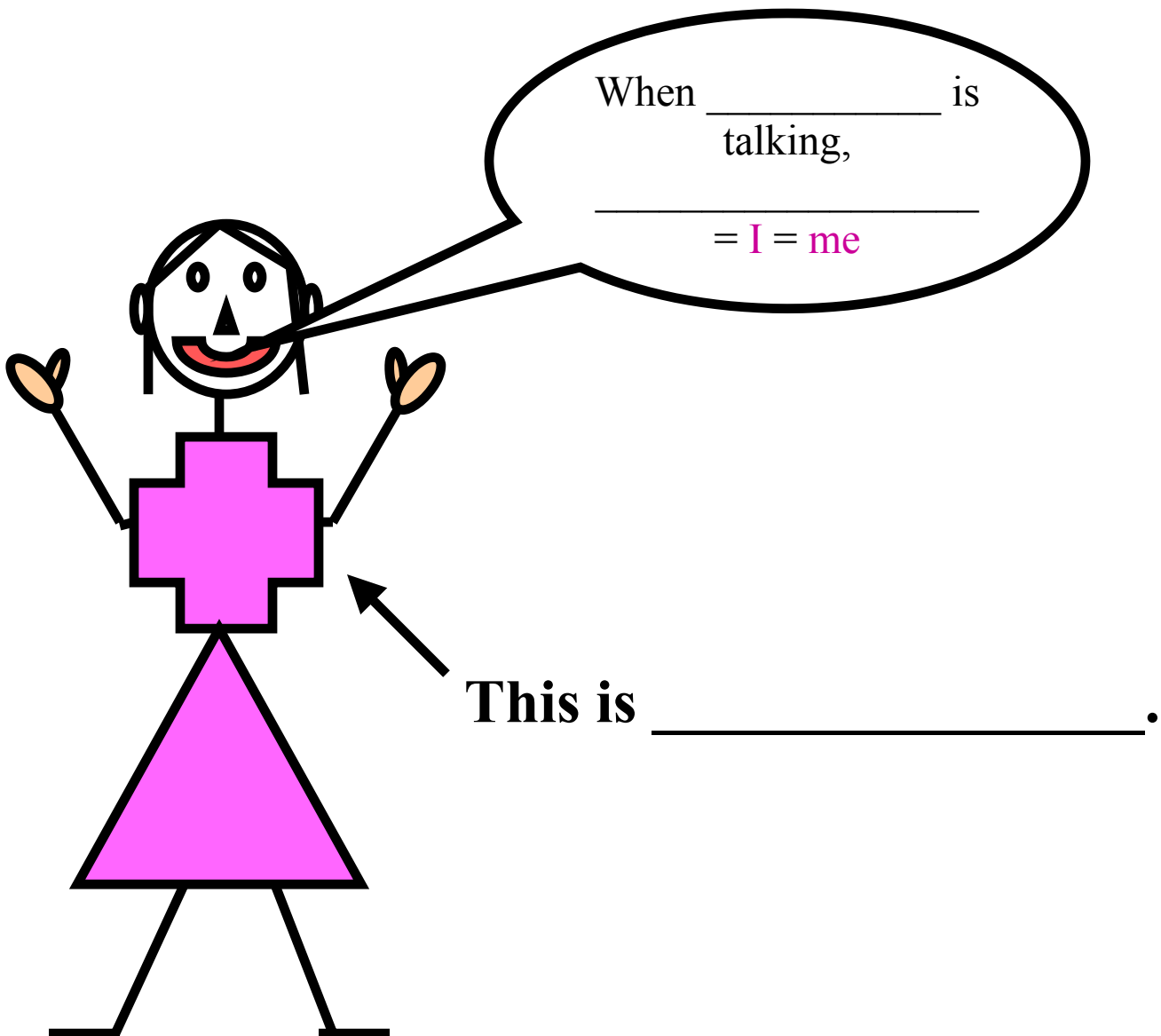

Person listening = you

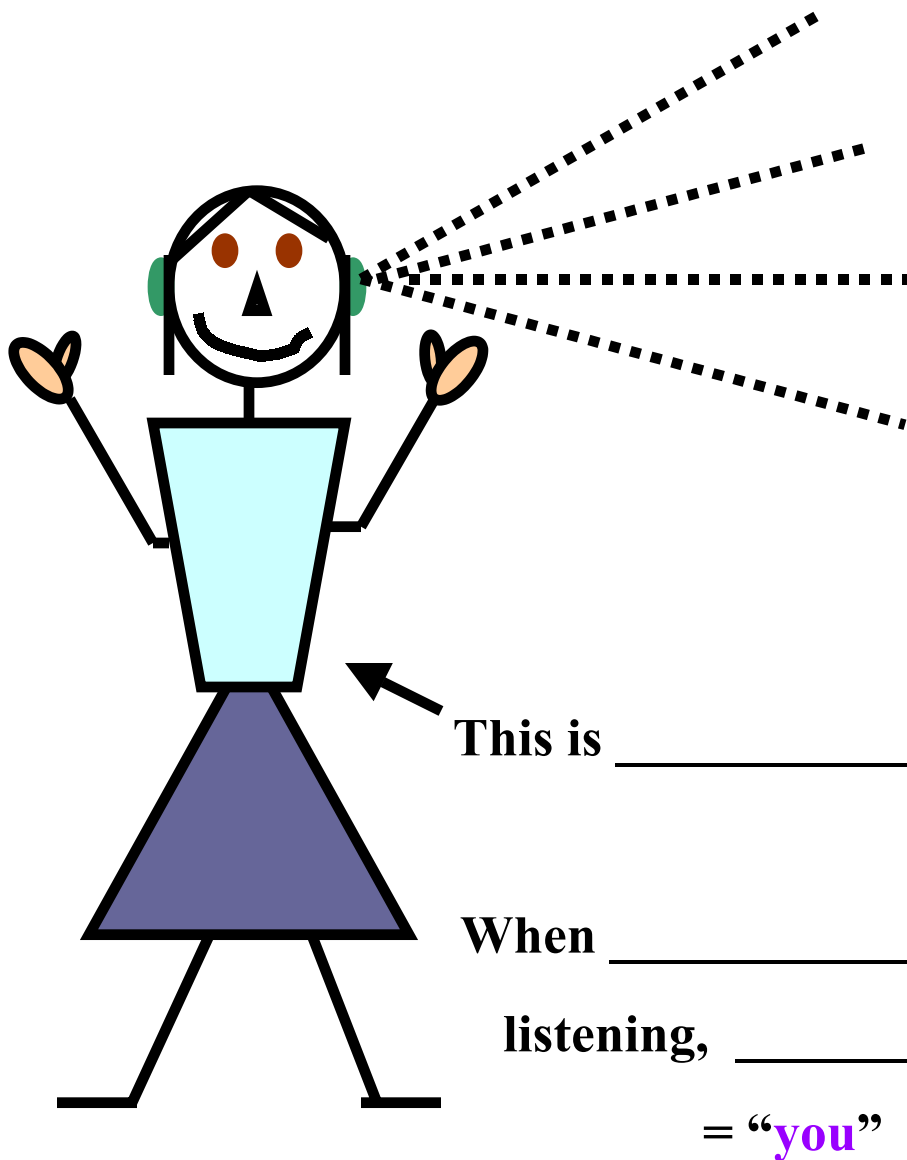

This is _____.

When _____ is

listening, _____ = you

But...

When _____ starts talking,

_____ = I = me.

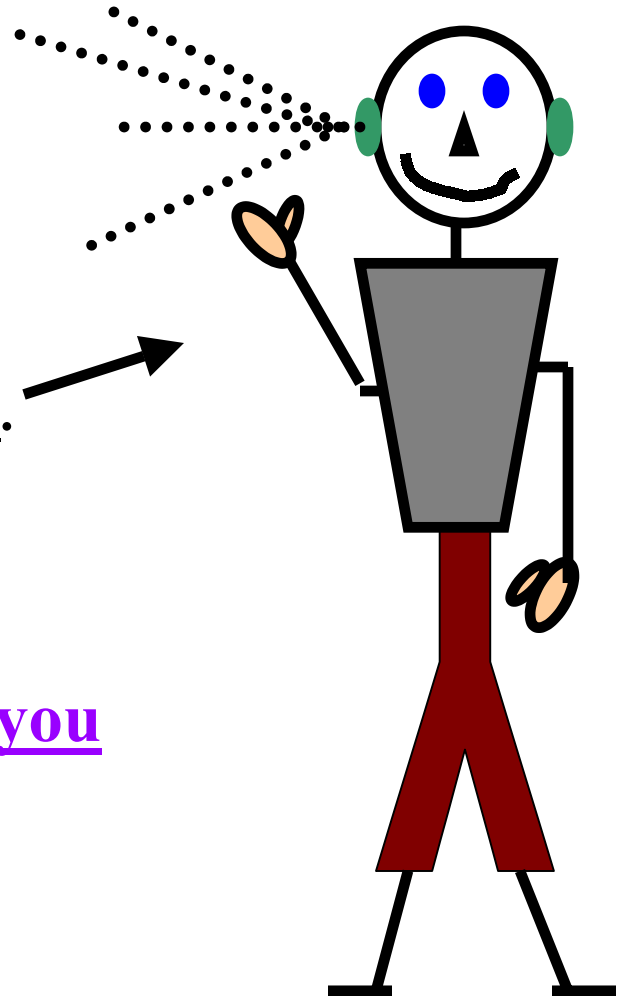

Some times, there is **more than one person listening to the one person talking...**

The **person talking** is still = **I or me...**

There can only be **one I or me** at one time because only one person can talk at one time...

But, there can be many people listening at one time, so...

All the people listening = you



I, me and you

The “Flip Flopping” Pronouns...

When _____
(my name)

is talking to _____
(another person)

_____ = “I” or “me”
(person talking)

and _____ = “you”.
(the other person = person listening)

I, me and you

The “Flip Flopping” Pronouns...

When _____
(name of new person talking)

is talking to _____
(my name)

_____ = “I” or “me”
(person talking)

and _____ = “you”.
(the other person = person listening)

So, just like people “**take turns**” talking...

They also “take turns” being “**you**” or “**I**” or “**me**”...

Person talking = I or me

Person listening = you

I = me
= person talking

**Some times, people talk to one
another by writing words on
paper for someone else to
read, so...**

I = me
= person talking
or person writing

There are many, many other pronouns or words to take the place of nouns.

Remember:

All pronouns are “shortcuts” or “easier ways to say something”...

The following are other pronouns people use when talking...

Pronouns...

my, mine, he, she, him, her, his, hers, your, yours, its,
our, ours, their, theirs, who, whose, they, them, we,
anybody, anyone, another, each, either, everybody,
everyone, nobody, no one, neither, one, other,
someone, somebody, many, both, few, several, others,
all, any, some, none, this, that, those, these, who,
whose, whom, which, what, whoever, whomever,
whatever, whichever...

and don't forget...

I, me.... you...

are **pronouns**, too!

Remember: Pronouns are “shortcuts” people use when talking or writing... they take the place of the name of a **person**, **place** or **thing**...

Understanding **pronouns** is very important... so, we will look at them a little more...

Pronouns...

Some pronouns “work together”...

I	=	me	=	my/mine
you	=	you	=	your/yours
he	=	him	=	his
she	=	her	=	her, hers
it	=	it	=	its
we	=	us	=	our/ours
they	=	them	=	their/theirs

this/that	=	these/those
------------------	---	--------------------

Here are a few examples of how to use
pronouns...

Zachary is happy.

That boy is happy.

He is happy.

boy = noun

he = pronoun = takes place of boy

The dog belongs to Zachary.

The dog belongs to the boy.

The dog is his.

It belongs to him.

his = pronoun = takes place of “the boy” and shows the dog belongs to “the boy”

it = pronoun = takes place of “the dog”

him = pronoun = takes the place of “the boy” and shows the dog belongs to “the boy”

I have a dog.

This is my dog.

This dog belongs to me.

This dog is mine.

**I, me, my and mine are all
pronouns used by the person
talking to talk about
something relating to
“myself”.**

I = me = my = mine

I

= person talking

= me

= my

= mine

You

= person(s) listening

Remember:

There can be many people listening at once...

You = one person or many persons listening...

you	=	you						
you	=	you	+	him				
you	=	you	+	her				
you	=	you	+	them				
you	=	you	+	he	+	she		
you	=	you	+	him	+	her		
you	=	you	+	you	+	you		
you	=	you	+	you	+	you	+	you
you	=	you	+	you	+	you	+	them

You = one person listening

or

You = many persons listening

or

You = some persons listening

or

You = all persons listening

he
= the boy
= that boy
= him

Remember:

Animals can be “boy animals” or “male animals”, too... so, “that boy” could be used to talk about a “male or boy dog” or a “male or boy horse” and so, people use “he” or “his” when talking about “boy or male animals”, too!

boy = male = he = him

she
= the girl
= that girl
= her (s)

Remember:

Animals can be “girl animals” or “female animals”, too... so, “that girl” could be used to talk about a “female or girl dog” or a “female or girl horse” and so, people use “she” or “her” when talking about “girl or female animals”, too!

girl = female = she = her(s)

They... Them... Their(s)

= **almost** the same thing as
 “you” ... **but not quite**...

Remember:

“You” could be only 1 person listening... or many persons listening or being talked about...

To use “**they**”, or “**their**” or “**them**” there must be **at least 2** or more persons listening or being talked about...

They / them / their	=	him	+	her				
They / them / their	=	him	+	him				
They / them / their	=	her	+	her				
They / them / their	=	you	+	him				
They / them / their	=	you	+	her				
They / them / their	=	you	+	them				
They / them / their	=	you	+	he	+	she		
They / them / their	=	you	+	him	+	her		
They / them / their	=	you	+	you	+	you		
They / them / their	=	you	+	you	+	you	+	you
They / them / their	=	you	+	you	+	you	+	them

Note: “They” does **not** include I or me or my or mine...

“They” only takes about “other people” when there are 2 or more than 2 “other people”!

Pronouns...

There are some pronouns that are used by the person talking or writing to talk about himself or herself, like...

I, me, my, mine...

And....

There are some pronouns that are used by the person talking or writing to talk about “other people”, like...

**you, he, she, him, her(s), they, them,
their(s)...**

But...

There are also pronouns that are used to talk about **both...**

These are pronouns that put together

I + you =

we, us, our(s)...

We... Us... Our(s)

I + you

= we = us = our

Note: When you see a “forward slash” like this (/), just use one of the words available...

we = I + you or we = me + you

us = I + you or us = me + you

our(s) = mine + yours or our = my + your(s)

our = me + you

we/us/our(s)	=	me/I/my/mine	+	you(r)(s)						
we/us/our(s)	=	me/I/my/mine	+	he						
we/us/our(s)	=	me/I/my/mine	+	him						
we/us/our(s)	=	me/I/my/mine	+	her						
we/us/our(s)	=	me/I/my/mine	+	them/they						
we/us/our(s)	=	me/I/my/mine	+	him	+	her				
we/us/our(s)	=	me/I/my/mine	+	him	+	him				
we/us/our(s)	=	me/I/my/mine	+	her	+	her				
we/us/our(s)	=	me/I/my/mine	+	you(r)(s)	+	him				
we/us/our(s)	=	me/I/my/mine	+	you(r)(s)	+	her				
we/us/our(s)	=	me/I/my/mine	+	you(r)(s)	+	them				
we/us/our(s)	=	me/I/my/mine	+	you(r)(s)	+	he	+	she		
we/us/our(s)	=	me/I/my/mine	+	you(r)(s)	+	him	+	her		
we/us/our(s)	=	me/I/my/mine	+	you(r)(s)	+	you(r)(s)	+	you(r)(s)		
we/us/our(s)	=	me/I/my/mine	+	you(r)(s)	+	you(r)(s)	+	you(r)(s)	+	you(r)(s)
we/us/our(s)	=	me/I/my/mine	+	you(r)(s)	+	you(r)(s)	+	you(r)(s)	+	them

We...

The **girl** and **I** went to the store.

She and **I** went to the store.

We went to the store.

Rule: **We** = **she** + **I**

He and **she** and **I** are friends

They and **I** are friends.

Rule: **We** = **he** + **she** + **I**

We are friends.

Rule: **We** = **they** + **I**

My mother, **my sister** and **I** are eating.

We are eating.

Rule: **We** = **she** + **she** + **I**

Rule: **We** = **they** + **I**

We always includes

Me or I + another person(s)!

Us...

Give it to **me** and **her**.

Give it to **us**.

Rule: **Us** = **me** + **her**

That belongs to **you**, **her**, and **me**.

That belongs to **you** and **me**.

Rule: **Us** = **you** + **her** + **me**

That belongs to **us**.

Rule: **Us** = **you** + **me**

It was **him** and **I** who did it.

It was **us** who did it.

Rule: **Us** = **him** + **I**

Us always includes

Me or I + another person(s)!

Our(s)...

It is **her** cat and **mine**.

It is **our** cat.

Rule: **Our** = **mine** + **her(s)**

That house belongs to **you**, **her**, and **me**.

It is **our** house.

Rule: **Our(s)** = **you(s)** + **her(s)** + **me**

His book and **my** pencil were outside.

Our things were outside.

Rule: **Our** = **his** + **my**

It belongs to **you** and **I**.

It is **ours**.

Rule: **Ours** = **you(s)** + **mine**

Our(s) = **mine** + **someone else's**

It(s)...

“It” is an easy pronoun to understand...

“It” takes the place of a thing or animal.

The table is brown.

It is brown.

The cat is sleeping.

It is sleeping.

The cat heard her kittens calling.

It heard its kittens calling.

There are many, many sentences you can make using pronouns...

The easiest way to understand how pronouns work is to listen to other people talking...

Once you know pronouns take the place of persons, places, and things, then, you just figure out what the pronoun is taking the place of...

Remember:

Be careful when it comes to “flipping pronouns”...

I = me = person talking

you = person listening

these are “tricky” because they change or “flip flop” with “whose talking”...

We (you + I) will do more on pronouns later...

Note To Parents...

To teach pronouns dealing with quantity, I used a favorite snack, such as gluten and casein free pretzels and showed Zachary the difference between “a few”, “some” “none”, “many”, “both”, “several”, etc.

This helped to provide a very concrete example for Zachary. These pronouns were not “flipping pronouns” and as such, the concept was much more easily grasped via a simple exercise as provided above.

In working with these pronouns, I also made sure all of Zachary’s pronoun usage was correct... if not, I would correct him by literally telling him what to say. For example, if I said, “how many do you want?”... I made sure he responded with “I want” as opposed to just saying the one word such as “many”... he had to include the “I want...” in his request. If he said something like: “give you three...”... I replied: “Say... Give me three...”. I literally told Zachary what to say by using the word... “Say...” to show him the appropriate response.

Proper pronoun usage was absolutely critical to the development of language skills and I believed the inability to “figure out” how pronouns work may be one of the many reasons children with autism were so delayed in their speech. The reason for that will be clearly evident as parents proceed through these materials. With better understanding of pronouns, there is no denying that Zachary’s speech was flourishing.

Interestingly, I noticed on a walk recently that when Zachary did not know what pronoun to use, he simply left it out of his sentence and said: “Anika, where are ... going?” He had left out the “you”... I corrected him and gave him the proper sentence by saying: “You say... Anika, where are you going?”

Of all the pronouns, without a doubt, “I, me and you” were the most difficult for Zachary to grasp and required the most work...

Until a child understood how speech worked, how could he use speech in the form of sentences/conversation? Pronouns, as you shall see, were absolutely critical in speech and quite frankly, it was only when I started to “graph them”, that I realized ***how*** critical understanding them truly was – as you, too, shall soon see for yourself – and when you do see that – you will understand why it is so hard for these children to understand how pronouns work. It would indeed be very difficult to figure it out, “on their own”, especially, since at least initially, children with autism, very much appear to “live via reference”... and if the references were “moving targets”, communication, and life overall, became difficult indeed!

As such, I strongly urged all parents to ensure proper pronoun usage by always correcting improper pronouns used by a child with autism and explaining the “why” for the correct usage by providing “a rule” as provided in these materials (i.e., “When Zachary is talking, Zachary = I = me = my = mine”, etc.).

More on pronouns later...

Note to parents...

Obviously, for a child to understand the “flipping pronouns” concept, he has to have an understanding of “taking turns”... this was a simple enough concept to teach via playing with a ball or using the “I love you and you love me” sentence and saying... “now your turn to say it...”

Understanding the concept of “taking turns” was thus critical to the understanding of proper pronoun usage for “flipping pronouns”...

Note to parents...

Time and time again, I had noticed that Zachary absolutely loved to do anything with colors, motion and sounds.

As such, I try to build sentences with Zachary that would include these things. Action verbs provide for the alluding to motion, but, where possible, I also tried to “act out” the motion as we work on language skills.

Colors were easily enough incorporated or alluded to. Just drawing his attention to the various colored parts of the “sentence train” or using different colored pencils or “color adjectives” was enough to keep Zachary interested in the task at hand.

I also tried to use sound as much as possible... Zachary loved onomatopoeias... these were words that sounded very much like their actual spelling. I provided a list of these on the following page. I knew that Zachary loved any sentence that included these ... he got very excited when I really emphasized the sound and/or acted it out.

I encouraged parents to make use of these words in “building sentences” also. :o)

Onomatopoeias...

ahhh	croak	ooph	splat
arf-arf	cuckoo	ouch	splutter
atchoom	ding-dong	paf	squeak
baa	drip	peek-a-boo	squish
bang	eeek	pitter-patter	swish
bark	fizz	plop	swoosh
beep-beep	flush	poof	tap
blink	growl	pop	thump
bloop	grrrr	pow	tick
blorp	gulp	purr	tick-tock
bong	gurgle	quack	tinkle
boo-hoo-hoo	ha-ha	ribbit-ribbit	twang
boom	he-haw	ring-a-ding-ding	tweet-tweet
bow-wow	he-he	ring-ring	uh-oh
brrrr	hiccup	rip	ummm
bump	hiss	roar	vroom
buzz	hmmm	rock	wah
chirp	ho-ho	ruff-ruff	wham
chomp	honk	rustle	wheeze
choo-choo	hoot	scratch	whir
clap	hooray	screech	whisper
click	hush	shhhh	whoa
click-clack	kaboom	shush	whoosh
cling-clang	la-de-da	sizzle	woof
clip-clop	maa	slam	wow
clop	meow	slurp	yahoo
cluck	moan	smash	yee-haw
cock-a-doodle-doo	moo	snap	yikes
crack	mumble	sniff	yippee
crackle	murmur	sniffle	zip
crash	neigh	spatter	zoom
creak	oink-oink	splash	
crunch	oops	splosh	

Opposites...

all	none
awake	asleep
big	small
black	white
city	country
clean	dirty
day	night
earth	sky
empty	full
fast	slow
first	last
fixed	broken
forward	backward
front	back
girl	boy
go	stop
good	bad
happy	sad
high	low
hot	cold
in	out
inside	outside
left	right
light	dark
light	heavy
morning	night
near	far
on	off
open	close
over	under
push	pull
quiet	loud
smooth	rough
soft	hard
stand	sit
start	finish
straight	crooked
sun	moon
sunny	rainy
sweet	sour
tall	short
top	bottom
up	down
wet	dry

Compound Words

back	+	yard	=	backyard
bath	+	room	=	bathroom
bath	+	tub	=	bathtub
birth	+	day	=	birthday
book	+	mark	=	bookmark
book	+	case	=	bookcase
book	+	keeper	=	bookkeeper
bottle	+	neck	=	bottleneck
car	+	pool	=	carpool
day	+	light	=	daylight
dog	+	house	=	doghouse
down	+	town	=	downtown
ear	+	ring	=	earring
earth	+	quake	=	earthquake
every	+	day	=	everyday
finger	+	print	=	fingerprint
fire	+	man	=	fireman
fire	+	place	=	fireplace
foot	+	print	=	footprint
foot	+	ball	=	football
gold	+	fish	=	goldfish
grass	+	hopper	=	grasshopper
hair	+	clip	=	hairclip
hill	+	top	=	hilltop
house	+	boat	=	houseboat
in	+	side	=	inside
key	+	chain	=	keychain
light	+	house	=	lighthouse
lip	+	stick	=	lipstick
mail	+	man	=	mailman

mail	+	box	=	mailbox
mouse	+	trap	=	mousetrap
my	+	self	=	myself
news	+	paper	=	newspaper
night	+	light	=	nightlight
oat	+	meal	=	oatmeal
out	+	side	=	outside
over	+	all	=	overall
pea	+	nut	=	peanut
pitch	+	fork	=	pitchfork
police	+	man	=	policeman
pop	+	corn	=	popcorn
quick	+	sand	=	quicksand
rail	+	road	=	railroad
sail	+	boat	=	sailboat
sand	+	bar	=	sandbar
sauce	+	pan	=	saucepan
seat	+	belt	=	seatbelt
snow	+	flake	=	snowflake
some	+	day	=	someday
some	+	where	=	somewhere
some	+	time	=	sometime
some	+	body	=	somebody
sun	+	light	=	sunlight
tooth	+	paste	=	toothpaste
trash	+	can	=	trashcan
under	+	ground	=	underground
wall	+	paper	=	wallpaper
water	+	fall	=	waterfall
your	+	self	=	yourself

People use “sentences” when they talk.

A sentence is made by putting together different kinds of words in a way that “makes sense”.

There are many different kinds of words.

**Nouns, pronouns, adjectives, articles, verbs, adverbs,
conjunctions, prepositions**

There are also different kinds of sentences.

There are many different kinds of words in a sentence.

Making a sentence is like building a train...

I just put parts together...

and the parts can sometimes move around...

but, they always have to make sense!

Make sense = not silly

Silly = makes no sense

Example: The house is running.

That is a “silly sentence” because a house can not run.

We do not use silly sentences when we talk.

We only use sentences that make sense.

To start building a sentence train, I have to know all the parts available and then try to put them together so they make sense and are “not silly”.

Sentence Parts:

**nouns, pronouns, adjectives, articles, verbs, adverbs,
conjunctions, prepositions**

Some sentences have lots of parts...

Some sentences only have one or two parts...

**Building a sentence train will help me understand how
a sentence works...**

**A train has different parts...
and each part has a specific function or purpose.**

A function is what something does.

**A train can have lots of parts.
Each part has a specific function.**

For example, a train engine pulls the train.

“the part” = the engine

“the function” of the engine = pull the train.

The train engine “is doing something”.

A sentence can have lots of parts too...

And each sentence part also has a specific function.

A sentence has “an engine” too...

it is called a “verb”

sentence engine = a verb

**The verb is the part of the sentence that
“does something”.**

Now, we need to build a sentence train.

a verb = the sentence engine = does something

We’ll put our sentence engine in a square...

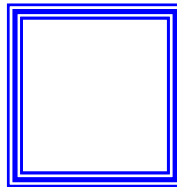

verb = sentence engine

The Verb...

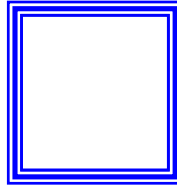

verb = sentence engine

Although sentences usually have lots of words, some sentences only have one word.

The one word all sentences must have is...

a verb

**A train needs an engine to do something.
Sometimes, we see just the train engine going
down the track.**

**A verb is like a train engine... it can work kind of
by itself or have lots of other parts tied to it.**

Interjections...

There are special words called “interjections” that can also be one word sentences in and of themselves...

These would include things like:

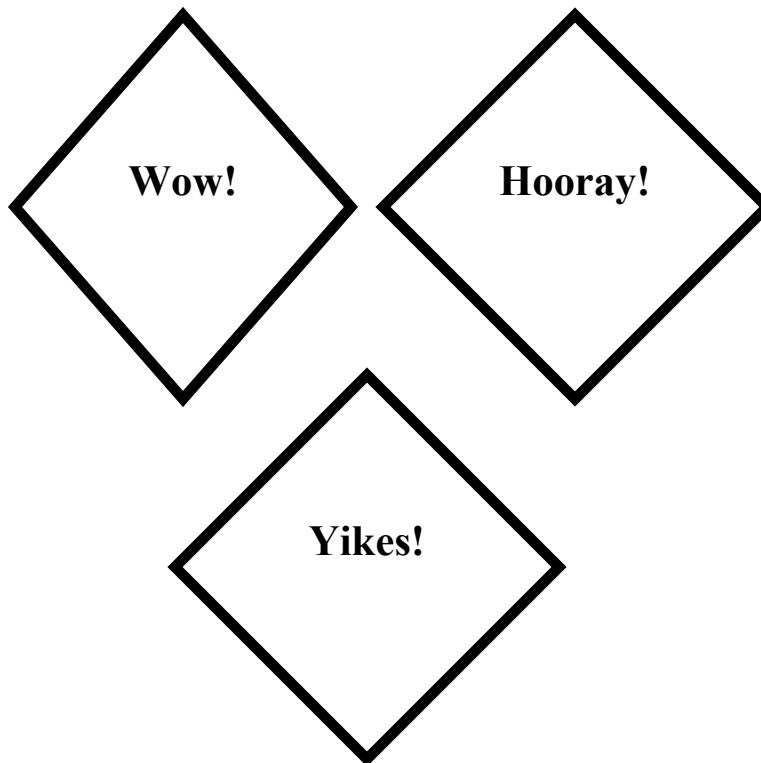

There are many different kinds of train engines.

**There are steam engines, oil engines, coal engines,
electric engines, etc.**

**There are also many, many sentence engines – or
verbs I can use in a sentence train.**

**The following few pages have lots of sentence
engines to choose from to build a sentence train.**

**Remember: A sentence train needs at least one
engine – or verb – to work!**

**These are only a few of the sentence engines - verbs
– I can use.**

There are many other verbs I could also use.

Remember: a sentence engine = a verb

A verb = an action word = doing something

Note To Parents...

In working with verb tenses, it was important to be very careful about the wording of sentences in order not to confuse a child.

For example, although the words “now, yesterday, and tomorrow” were great helpers in determining present, past and future tenses, a poorly worded phrase could easily cause confusion. Take the following examples:

Now, I will go to the store.

In this example, the verb is future tense although it was used with the word “now”.

**A better sentence to teach “present” using “now” would be:
Now, I am going to the store.**

Some people like to use the word “today” for present... in my opinion, that can be even more confusing. Look at the following examples:

Today, I went to the store. (past)

Today, I am going to the store. (present)

Today, I will be going to the store. (future)

All three sentences “are valid” and grammatically correct... but only one teaches the “present” using the verb “am going”. As such, parents need to be extremely careful to make sure that the “helping word” (i.e., now, today, yesterday, tomorrow) is one that absolutely matches the verb tense or else, confusion will surely reign.

Verb Tense

a sentence engine = a verb

a verb = an action word =

what's happening and when

An “**action**” can be something...

being done now = still doing it = PRESENT tense

already finished = already done = PAST tense

not started yet = done later on = FUTURE tense

Verb Tenses...

Now = PRESENT

Finished = PAST

Not Started Yet = FUTURE

Action words = verbs
= what's happening and when

Verbs can change based on present, past or future

I am swimming in a cold lake. = PRESENT = doing it now

I swam in a cold lake. = PAST = all done

I will swim in a cold lake. = FUTURE = not started yet

Some words can help me to figure out the correct **verb tense** if I put them first in the sentence.

If I use the word **NOW**, that helps me figure out the **PRESENT** verb tense.

If I use the word **YESTERDAY**, that helps me figure out the **PAST** verb tense.

If I use the word **TOMORROW**, that helps me figure out the **FUTURE** verb tense.

Now = Present

All done = Past

Not started yet = Future

Verb = Action word = What's happening and when

I need to ask myself:

“When does the action take place”?

Is it now, or something already done, or something to be done later?

NOW = doing it now = PRESENT verb tense

YESTERDAY = already done = PAST verb tense

TOMORROW = doing it later = not started yet = FUTURE tense

Verb Tense...

Now, I am swimming in a cold lake. = PRESENT = now

Yesterday, I swam in a cold lake. = PAST = all done

Tomorrow, I will swim in a cold lake. = FUTURE = not started yet

Now = Present

All done = Past

Not started yet = Future

Verb Tense = Present, Past or Future

**There are other verb tenses, too... I can learn those
when I get older...**

When is the action (verb) happening ?

Verb	Present = doing it now	Present Participle = Incomplete action = continuous form of the verb	Past = all done = finished doing it	Future = not started yet = doing it soon or later on Note: With pronouns “<u>I</u>” and “<u>we</u>”, you can also use “<u>shall</u>” instead of “<u>will</u>”
to bake	bake(s)	baking	baked	will bake
to be	is, am, are,	being	was, were	will be
to beat	beat(s)	beating	beat	will beat
to begin	begin(s)	beginning	began	will begin
to bite	bite(s)	biting	bit	will bite
to blow	blow(s)	blowing	blew	will blow
to bounce	bounce(s)	bouncing	bounced	will bounce
to break	break(s)	breaking	broke	will break
to bring	bring(s)	bringing	brought	will bring
to brush	brush(es)	brushing	brushed	will brush
to build	build(s)	building	built	will build
to burst	burst(s)	bursting	burst	will burst

Verb	Present = doing it now	Present Participle = Incomplete action = continuous form of the verb	Past = all done = finished doing it	Future = not started yet = doing it soon or later on Note: With pronouns “<u>I</u>” and “<u>we</u>”, you can also use “<u>shall</u>” instead of “will”
to buy	buy(s)	buying	bought	will buy
to carry	carry, carries	carrying	carried	will carry
to catch	catch, catches	catching	caught	will catch
to clap	clap(s)	clapping	clapped	will clap
to clean	clean(s)	cleaning	cleaned	will clean
to climb	climb(s)	climbing	climbed	will climb
to close	close(s)	closing	closed	will close
to color	color(s)	coloring	colored	will color
to comb	comb(s)	combing	combed	will comb
to come	come(s)	coming	came	will come
to cook	cook(s)	cooking	cooked	will cook
to crawl	crawl(s)	crawling	crawled	will crawl
to cry	cry, cries	crying	cried	will cry
to cut	cut(s)	cutting	cut	will cut
to dance	dance(s)	dancing	danced	will dance
to dig	dig(s)	digging	dug	will dig
to dive	dive(s)	diving	dived, dove	will dive
to do	do, does	doing	did	will do
to draw	draw(s)	drawing	drew	will draw

Verb	Present = doing it now	Present Participle = Incomplete action = continuous form of the verb	Past = all done = finished doing it	Future = not started yet = doing it soon or later on Note: With pronouns “<u>I</u>” and “<u>we</u>”, you can also use “<u>shall</u>” instead of “will”
to dream	dream(s)	dreaming	dreamed	will dream
to drink	drink(s)	drinking	drank	will drink
to drive	drive(s)	driving	drove	will drive
to eat	eat(s)	eating	ate	will eat
to fall	fall(s)	falling	fell	will fall
to feel	feel(s)	feeling	felt	will feel
to float	float(s)	floating	floated	will float
to fly	fly, flies	flying	flew	will fly
to fold	fold(s)	folding	folded	will fold
to freeze	freeze(s)	freezing	froze	will freeze
to give	give(s)	giving	gave	will give
to glue	glue(s)	gluing	glued	will glue
to go	go, goes	going	went	will go
to grow	grow(s)	growing	grew	will grow
to have	has, have	having	had	will have
to hear	hear(s)	hearing	heard	will hear
to hit	hit(s)	hitting	hit	will hit
to hop	hop(s)	hopping	hopped	will hop
to hope	hope(s)	hoping	hoped	will hope

Verb	Present = doing it now	Present Participle = Incomplete action = continuous form of the verb	Past = all done = finished doing it	Future = not started yet = doing it soon or later on Note: With pronouns “<u>I</u>” and “<u>we</u>”, you can also use “<u>shall</u>” instead of “will”
to hurt	hurt(s)	hurting	hurt	will hurt
to iron	iron(s)	ironing	ironed	will iron
to juggle	juggle(s)	juggling	juggled	will juggle
to jump	jump(s)	jumping	jumped	will jump
to kick	kick(s)	kicking	kicked	will kick
to knit	knit(s)	knitting	knitted	will knit
to knock	knock(s)	knocking	knocked	will knock
to know	know(s)	knowing	knew	will know
to laugh	laugh(s)	laughing	laughed	will laugh
to leave	leave(s)	leaving	left	will leave
to lick	lick(s)	licking	licked	will lick
to listen	listen(s)	listening	listened	will listen
to lock	lock(s)	locking	locked	will lock
to look	look(s)	looking	looked	will look
to make	make(s)	making	made	will make
to march	march, marches	marching	marched	will march
to mix	mix, mixes	mixing	mixed	will mix
to mop	mop(s)	mopping	mopped	will mop
to mow	mow(s)	mowing	mowed	will mow

Verb	Present = doing it now	Present Participle = Incomplete action = continuous form of the verb	Past = all done = finished doing it	Future = not started yet = doing it soon or later on Note: With pronouns "<u>I</u>" and "<u>we</u>", you can also use "<u>shall</u>" instead of "will"
to open	open(s)	opening	opened	will open
to pack	pack(s)	packing	packed	will pack
to paint	paint(s)	painting	painted	will paint
to paste	paste(s)	pasting	pasted	will paste
to pick	pick(s)	picking	picked	will pick
to plant	plant(s)	planting	planted	will plant
to play	play(s)	playing	played	will play
to pour	pour(s)	pouring	poured	will pour
to pull	pull(s)	pulling	pulled	will pull
to push	push, pushes	pushing	pushed	will push
to rake	rake(s)	raking	raked	will rake
to read	read(s)	reading	read	will read
to ride	ride(s)	riding	rode	will ride
to row	row(s)	rowing	rowed	will row
to run	run(s)	running	ran	will run
to sail	sail(s)	sailing	sailed	will sail
to saw	saw(s)	sawing	sawed	will saw
to say	say(s)	saying	said	will say
to scare	scare(s)	scaring	scared	will scare

Verb	Present = doing it now	Present Participle = Incomplete action = continuous form of the verb	Past = all done = finished doing it	Future = not started yet = doing it soon or later on Note: With pronouns “<u>I</u>” and “<u>we</u>”, you can also use “<u>shall</u>” instead of “will”
to scream	scream(s)	screaming	screamed	will scream
to scrub	scrub(s)	scrubbing	scrubbed	will scrub
to see	see(s)	seeing	saw	will saw
to sew	sew(s)	sewing	sewed	will sew
to shout	shout(s)	shouting	shouted	will shout
to show	show(s)	showing	showed	will show
to sing	sing(s)	singing	sang	will sing
to sink	sink(s)	sinking	sank, sunk	will sink
to sip	sip(s)	sipping	sipped	will sip
to sit	sit(s)	sitting	sat	will sit
to skate	skate(s)	skating	skated	will skate
to ski	ski(s)	skiing	skied	will ski
to skip	skip(s)	skipping	skipped	will skip
to sleep	sleep(s)	sleeping	slept	will sleep
to slice	slice(s)	slicing	sliced	will slice
to slide	slide(s)	sliding	slid	will slide
to smell	smell(s)	smelling	smelled	will smell
to sneeze	sneeze(s)	sneezing	sneezed	will sneeze
to speak	speak(s)	speaking	spoke	will speak

Verb	Present = doing it now	Present Participle = Incomplete action = continuous form of the verb	Past = all done = finished doing it	Future = not started yet = doing it soon or later on Note: With pronouns “<u>I</u>” and “<u>we</u>”, you can also use “<u>shall</u>” instead of “will”
to spin	spin(s)	spinning	spun	will spin
to stand	stand(s)	standing	stood	will stand
to start	start(s)	starting	started	will start
to steal	steal(s)	stealing	stole	will steal
to stop	stop(s)	stopping	stopped	will stop
to stretch	stretch, stretches	stretching	stretched	will stretch
to study	study, studies	studying	studied	will study
to sweep	sweep(s)	sweeping	swept	will sweep
to swim	swim(s)	swimming	swam	will swim
to swing	swing(s)	swinging	swung	will swing
to take	take(s)	taking	took	will take
to talk	talk(s)	talking	talked	will talk
to taste	taste(s)	tasting	tasted	will taste
to teach	teach, teaches	teaching	taught	will teach
to tell	tell(s)	telling	told	will tell
to think	think(s)	thinking	thought	will think
to throw	throw(s)	throwing	threw	will throw
to tie	tie(s)	tying	tied	will tie
to touch	touch, touches	touching	touched	will touch

Verb	Present = doing it now	Present Participle = Incomplete action = continuous form of the verb	Past = all done = finished doing it	Future = not started yet = doing it soon or later on Note: With pronouns “<u>I</u>” and “<u>we</u>”, you can also use “<u>shall</u>” instead of “will”
to trick	trick(s)	tricking	tricked	will trick
to wade	wade(s)	wading	waded	will wade
to walk	walk(s)	walking	walked	will walk
to wash	wash, washes	washing	washed	will wash
to wave	wave(s)	waving	waved	will wave
to wear	wear(s)	wearing	wore	will wear
to whistle	whistle(s)	whistling	whistled	will whistle
to wipe	wipe(s)	wiping	wiped	will wipe
to work	work(s)	working	worked	will work
to wrap	wrap(s)	wrapping	wrapped	will wrap
to write	write(s)	writing	wrote	will write
to yawn	yawn(s)	yawning	yawned	will yawn
to zip	zip(s)	zipping	zipped	will zip

There are many, many other verbs and many other verb tenses too, but present, present participle, past and future verb tenses are the most important ones to know!

Helping Verbs...

Sometimes, **the verb** has a few extra words tied to it...
these are called “**helping verbs**”.

Helping verbs are used to make verb phrases...

**I can use one or more of these along with my verb or
action word... helping verbs can include one or
more words...**

These are examples of “helping verbs”...

**do, does, did, has, have, had, is, am,
are, was, were, be, being, been, may,
must, might, could, should, would,
can, shall, will, to be, to go, can be,
must have, must have been, has been,
is being, could have been, should be,
will have been, might be, were
being...**

there are many others too...

Examples of sentences using different verb tenses are provided below...

1. Peter walks slowly to the store. = **Present**
2. Peter walked slowly to the store. = **Past**
3. Peter will be walking slowly to the store = **Future**

The only thing that changed in the sentence was the **verb**. All other parts stayed exactly the same!

Just changing the **verb tense** can tell me if the action is happening **now (present)**, is already **finished (past)** or **will be done soon/later on (future)**.

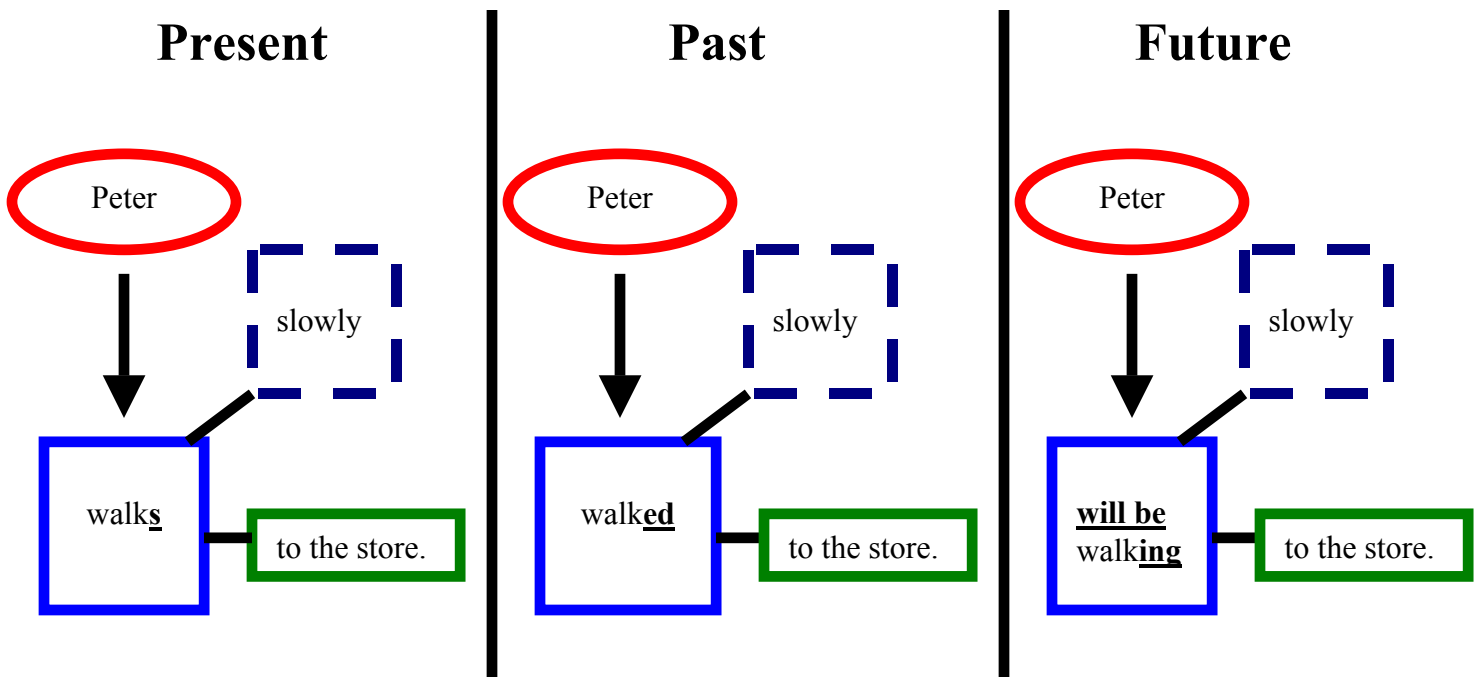

So, now I know that in my sentence train, the
“**action word**” is the **verb**.

the verb = sentence train engine

And...

I know the **verb** can tell me something about the
action...

It can tell me if the action is taking place **NOW...**

NOW = Present Tense

It can tell me if the action is already **FINISHED...**

FINISHED = Past Tense

It can tell me if the action has not started yet but is
going to happen **SOON/LATER...**

SOON/LATER = Future Tense

Remember: There are many other verb tenses.
I can learn them as I get older.

Although computers can run some trains, most trains have a conductor...

a conductor = a person who drives the train

A sentence train has a conductor, too...

The person who drives the sentence train is called

“the subject”

The subject is who or what is working with the engine in the sentence train.

The subject = who or what the sentence is about.

The subject is almost always a noun.

Subject = sentence train conductor = noun

Subject

= sentence train
conductor

= noun

Now, I need to add my sentence train conductor – **the subject** - to the sentence train engine.

Subject = sentence train conductor = noun

I will put my sentence train conductor – **the subject** - in an oval...

subject

Now, I have a conductor – **the subject** - and an engine – **the verb** - for my sentence train so, I need to put them together.

Subject = sentence train conductor = almost always a noun or pronoun

A verb = the sentence engine = does something

Since the **subject** is a **conductor** and directs the train, I will put the conductor just in front of **the verb – the engine** - in my sentence train.

Sentence Conductor = Subject = Noun

Sentence Engine = Verb = Does Something

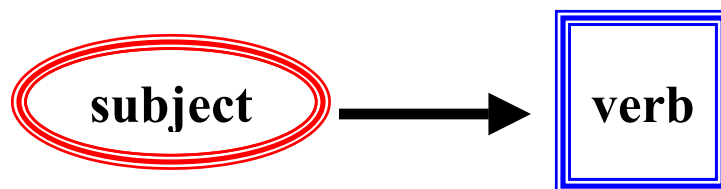

**subject = sentence train conductor = who or what
the sentence is about**

verb = sentence train engine = action

A NOUN

A Noun = a person, place or thing

There are two types of nouns:

1. Proper nouns = name of a specific person, place or thing

Zachary

Johnson Pizza House

Pacific Ocean

2. Common nouns = most types of nouns

house

cat

bike

mother

beach

NOUN = PERSON, place or thing

A Person = a human = not an animal = not a thing

A Person = someone = somebody

A person is ALWAYS =

A BOY

Or

A GIRL

A MAN

Or

A WOMAN

WHO Is A Person?

A Person = somebody like...

PERSON = WHO = SOMEBODY

**mom, dad, sister, brother, friend, grandma, grandpa,
aunt, uncle, cousin, neighbor, teacher, doctor,
fireman, policeman, mailman, painter, dancer, writer,
farmer, clockmaker, runner, swimmer, nurse,
construction worker, helper, babysitter, baby, artist,
janitor, driver, train engineer, baker, butcher, judge,
mechanic, musician, factory worker, dentist, visitor,
repairman, storekeeper, saleswoman –
and other people too.**

A person always = a boy, girl, man, or woman.

A PERSON = SOMEBODY = SOMEONE = WHO

WHO IS IT?

A person always = a boy, girl, man, or woman.



BOY



GIRL



MAN



WOMAN

NOUN = person, PLACE or thing

A place = somewhere I can go = somewhere I can be

WHERE Is A Place?

A Place = somewhere I can go, like...

PLACE = WHERE = SOMEWHERE

**home, park, beach, school, church, store, office,
library, playground, jail, city, town, province, country,
service counter, bathroom, bedroom, Chicago,
Toronto, Los Angeles, Ottawa, Denver, Washington
D.C., Paris, Tokyo, Seoul, Calgary, Ontario, Manitoba,
Nova Scotia, Newfoundland, Illinois, California,
Vermont, New York, Utah, Argentina, Brazil, Japan,
China, United States, Canada, Spain, Guatamala,
Portugal, England, and many, many other places.**

A PLACE = WHERE = SOMEWHERE

NOUN = person, place, or THING

A thing = something = an object or animal

Almost everything is “a thing”. Many things are not alive but some are...

**Animals, birds, insects and plants are examples of things that are alive
but that are not persons – so, these are “things”.**

WHAT Is A Thing?

A Thing = something like...

THING = WHAT = SOMETHING

**house, clock, bed, table, chair, sink, floor, door, grass,
sun, cup, spoon, plate, book, computer, telephone,
stove, light, fire, step, slide, car, truck, sweater, pants,
coat, shoes, paper, pencil, window, mirror, picture,
sand, food, box, trailer, boat, plane, chalk, couch,
fence, dog, cow, bluebird, grasshopper, bee, flower,
tree, star, moon, sky, cloud, rain, steam, toy, doll,
shower, bath, pillow, towel, curtain, shade, shadow,
and many, many other “things”.**

A THING = WHAT

There are many, many things...

These are just a few more nouns that are “things”...

THING = WHAT = SOMETHING

name, blanket, blimp, block, blouse, branch, bread, brick, bridge,
broom, brush, butter, spoon, knife, fork, tablecloth, chain, chair,
cheese, crackers, pot, chick, children, chipmunk, clothes, cloud, clown,
club, crab, crumbs, crayons, crib, cross, crown, dream, dress, drum,
flute, guitar, piano, poster, flag, flame, spark, fly, frame, picture, frog,
fruit, glass, cup, globe, map, glove, mitten, scarf, glue, grape, grass,
grasshopper, ladybug, snail, wasp, bee, ant, knee, knife, knock, knob,
knot, plane, plant, plate, plum, pizza, prize, trophy, scale, scarecrow,
corn, pumpkin, potato, carrot, shark, sheep, rabbit, skunk, spider, skate,
shoe, ship, shell, slipper, smoke, snake, snow, spear, starfish, stick,
stone, stove, thorn, thumb, train, tree, cactus, twig, triangle, square,
circle, hexagon, shape, number, truck, trunk, whale, wheel, zoo,
monkey, ear, nose, teeth, arm, leg, foot, hand, carpet, desk, computer,
book, telephone, television, video, cd, medicine, pills, penny, dime,
quarter, nickel, orange, lemon, apple, stairs, turtle, water, woods,
zebra, giraffe, road, street, highway, rainbow, radio, car, shovel, rake,
toothbrush, toothpaste, people, peas, fingers, toes, dollar, garden, hair,
bow, arrow, lion, tiger, eraser, ladder, letter, frown, smile, face, ...

and there are many, many other things...

A THING = WHAT = SOMETHING

So, now I know that

A

NOUN =

A PERSON,

A PLACE,

Or

A THING...

Pronouns...

Pronouns = words that take the place of nouns

So, a **pronoun** can also be the **subject** in a sentence.

Example:

The **truck** is red. **It** is red.

It = pronoun = takes the place of “the truck”.

Anika is happy. **She** is happy.

She = pronoun = takes the place of “Anika”.

The **dog** and **cat** are fighting. **They** are fighting.

They = pronoun = takes the place of “the dog and cat”.

Pronouns...

Pronouns = words that take the place of nouns

So, a **pronoun** can also be the **subject** in a sentence.

Pronouns = words that take the place of nouns

**I, me, my, mine, he, his, she, her(s), we, us, our(s),
they, them, their(s), you, it(s), anybody, anyone,
another, each, either, everybody, everyone, nobody,
no one, neither, one, other(s), someone, somebody,
all, any, some, none, many, both, few, several,
themselves, myself, himself, herself, ourselves, that,
this, those, these, who, whose, whom, which, what,
whoever, whomever, whatever, whichever ...**

**All these words are examples of pronouns that take
the place nouns. There could be others, too.**

So, now I know that

A

NOUN =

A PERSON,

A PLACE,

Or

A THING...

And, I also know that, usually,

only a NOUN or PRONOUN can be a SUBJECT

NOUN or PRONOUN =

**SUBJECT = Who or What the
sentence is about =**

**SENTENCE TRAIN
CONDUCTOR**

So far, I have two parts to my sentence train...

sentence train engine = verb

sentence train conductor = subject

And, we know the **subject = noun(s) or pronoun(s)**

Subject = Who or What the sentence is about

Verb = Action the subject is doing

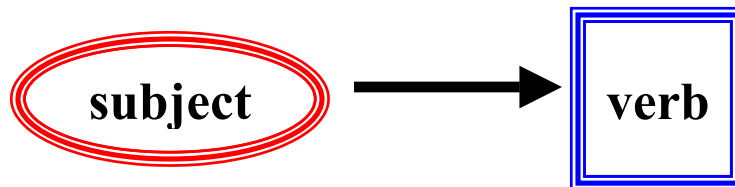

Example:

Anika laughed.

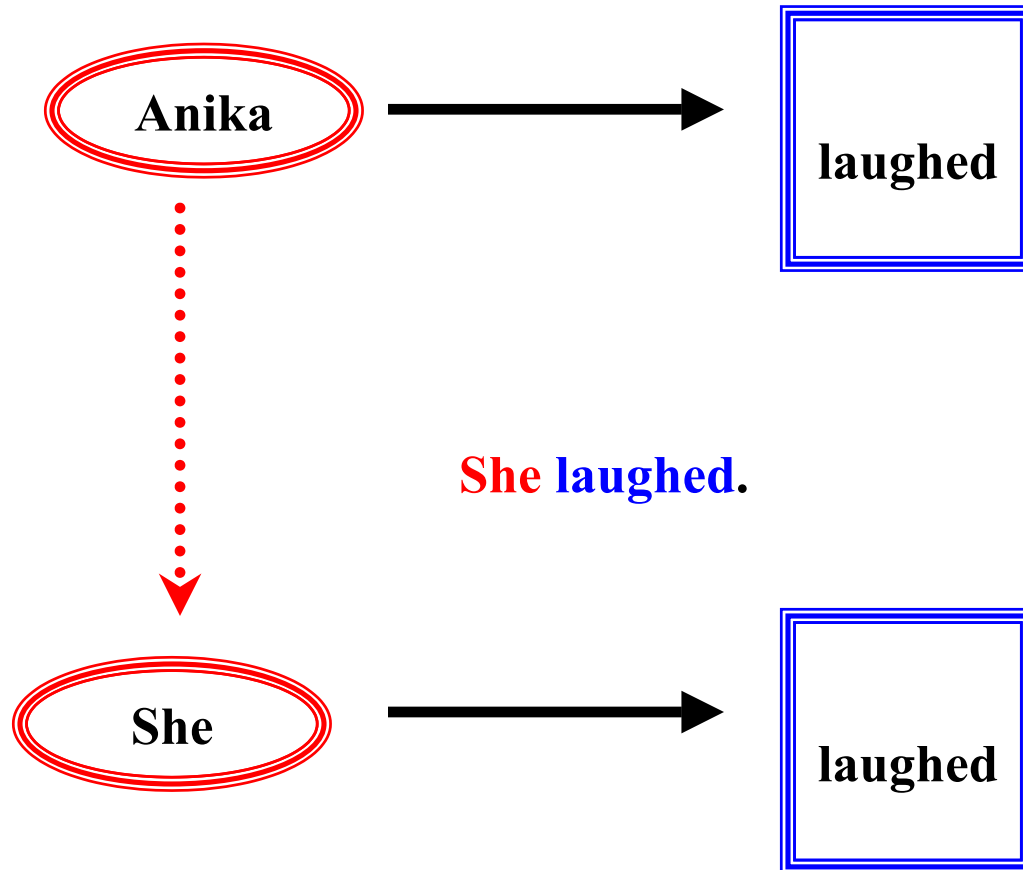

She laughed.

Anika = Proper noun = name of a person = subject

laughed = verb

or

She = pronoun = takes place of Anika = subject

laughed = verb

When people talk, they sometimes use
“shortcuts” called
“**contractions**”

Contractions are made of parts of 2 words...

Contractions can use part of a **pronoun** and
part of a **verb** or **helping verb**...

Contractions can also use part of a **verb** or
helping verb and an **adverb**...

So, they can be kind of a “**half pronoun**” +
“**half verb**” word... or “**half verb**” + “**half**
adverb” word...with some letters of either
word “left out” and replaced by an
apostrophe.

,

An apostrophe looks like this...

A contraction always has at least part of a **verb** or “**helping verb**” in it. The other part can be either a **pronoun** or an **adverb**.

Many contractions use the **adverb** “**not**”.

Although I use contractions in talking and writing, I will only use “full” or “complete” words in my sentence trains and will not use **contractions...**

But...

It is still important to understand **contractions** and be able to recognize what they mean.

Some **contractions** are made with **pronouns** and **verbs or helping verbs...**

Pronoun	+	Part of Verb or Helping Verb	=	Contraction
I	+	am	=	I'm
I	+	have	=	I've
I	+	would	=	I'd
I	+	will	=	I'll
you	+	will	=	you'll
they	+	will	=	they'll
we	+	will	=	we'll
he	+	is	=	he's
he	+	would	=	he'd
she	+	is	=	she's
she	+	would	=	she'd
they	+	have	=	they've
they	+	are	=	they're
it	+	is	=	it's
who	+	is	=	who's
what	+	is	=	what's
what	+	will	=	what'll

Some **contractions are made with the **adverb** first followed by a part of a **verb** or **helping verb**...**

Adverb	+	Part of Verb or Helping Verb	=	Contraction
where	+	is	=	Where's
where	+	will	=	Where'll
here	+	is	=	here's
here	+	will	=	here'll
now	+	will	=	now'll
now	+	is	=	now's
there	+	is	=	there's
there	+	will	=	there'll
when	+	is	=	when's
when	+	will	=	when'll
how	+	will	=	how'll
how	+	is	=	how's

Other contractions “flip” the adverb and verb or helping verb information...

like on the next page...

Some contractions are made with the **verb or **helping verb** first followed by part of an **adverb**...**

Part of Verb or Helping Verb	+	Adverb	=	Contraction
Do	+	not	=	don't
Does	+	not	=	doesn't
did	+	not	=	didn't
Has	+	not	=	hasn't
Have	+	not	=	haven't
Had	+	not	=	hadn't
Is	+	not	=	isn't
Are	+	not	=	aren't
Was	+	not	=	wasn't
Were	+	not	=	weren't
Must	+	not	=	mustn't
Might	+	not	=	mightn't
Should	+	not	=	shouldn't
Could	+	not	=	couldn't
Would	+	not	=	wouldn't
Will	+	not	=	won't
Can	+	not	=	can't

There are probably other contractions, but these are the most common ones you'll here.

Putting **contractions** in a sentence train is easy...

All I need to do is use the 2 original words that were used to make the **contraction**...

Here are a few examples of how to show **contractions** that use a **pronoun** and a **verb** or **helping verb**...

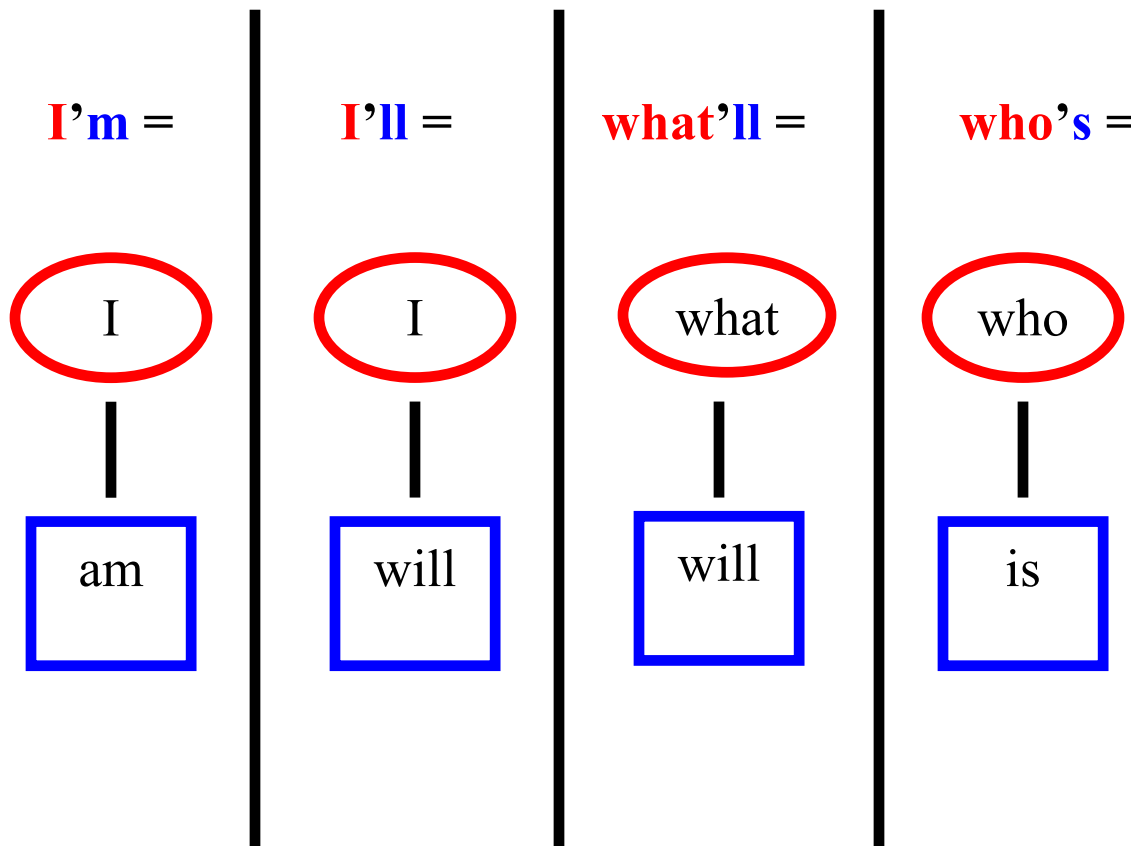

**Here are a few examples of how to show
contractions that use an adverb and a verb or
helping verb...**

didn't =

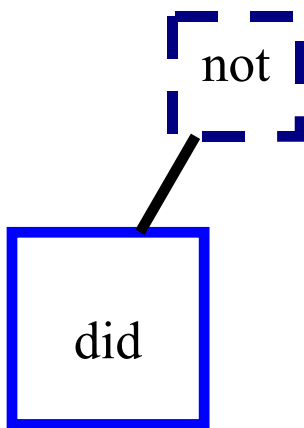

can't =

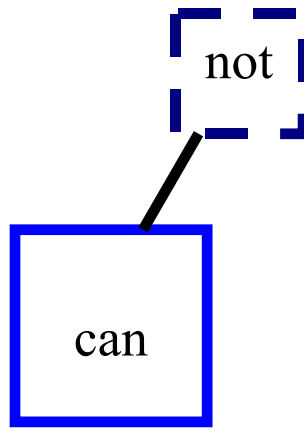

how's =

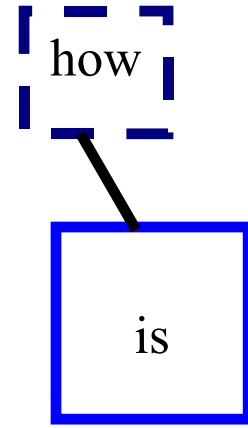

**My sentence train can have a lot more parts
to it... like...**

adjectives...

articles...

adverbs...

conjunctions...

prepositions...

etc.

**These are all “sentence parts” I can add to a
sentence train...**

Adjectives...

Adjectives = words that describe nouns = tells me something about the noun(s) = noun cargo

These are examples of adjectives ...

green, blue, yellow, red, brown, black, purple, orange, white, big, bigger, biggest, tall, taller, tallest, small, smaller, smallest, fat, dirty, clean, dark, happy, sad, mad, fast, slow, long, short, beautiful, pretty, simple, old, new, favorite, round, heavy, strong, weak, fragile, broken, twisted, cracked, funny, tired, warm, cold, cool, hot, chilly, cozy, little, hungry, sick, greedy, selfish, unselfish, generous, visible, invisible, trustworthy, untrustworthy, dependable, reliable, unreliable, unbelievable, accurate, inaccurate, violent, nonviolent, destructive, nondestructive, breakable, unbreakable, aggressive, unaggressive, best, worst, jealous, sleeping, barking, quiet, shy, right, left, middle, first, second, third, fourth, last, one, two, three, four, five, some, many, more, most, only, opened, closed, squeaky, loud, soft, gentle, sensitive, bitter, sour, sweet, salty, nasty, good, bad, mean, spoiled, fussy, wealthy, poor, cute, stinky, wet, dry, huge, sore, hurt, unhurt, polished, smooth, rough, our, their, his, her, my, that, those, this, calm, afraid, unafraid, full, empty, shining, joyful, playful, sharp, dull, distant, disabled, respectful, disrespectful, dizzy, silly, easy, hard, expensive, inexpensive, real, pretend, fake, rude, polite, smart, unique, talented, victorious, wishful, opinionated, thoughtful, sneaky, friendly, live, dead, deaf, mute, silent, blind, talkative, nice, excited, frantic, free, delicate, intelligent, brave, courageous, bright, delightful, thankful, awesome, ridiculous ...

and, there are many, many more adjectives too!

Adjectives tell me...

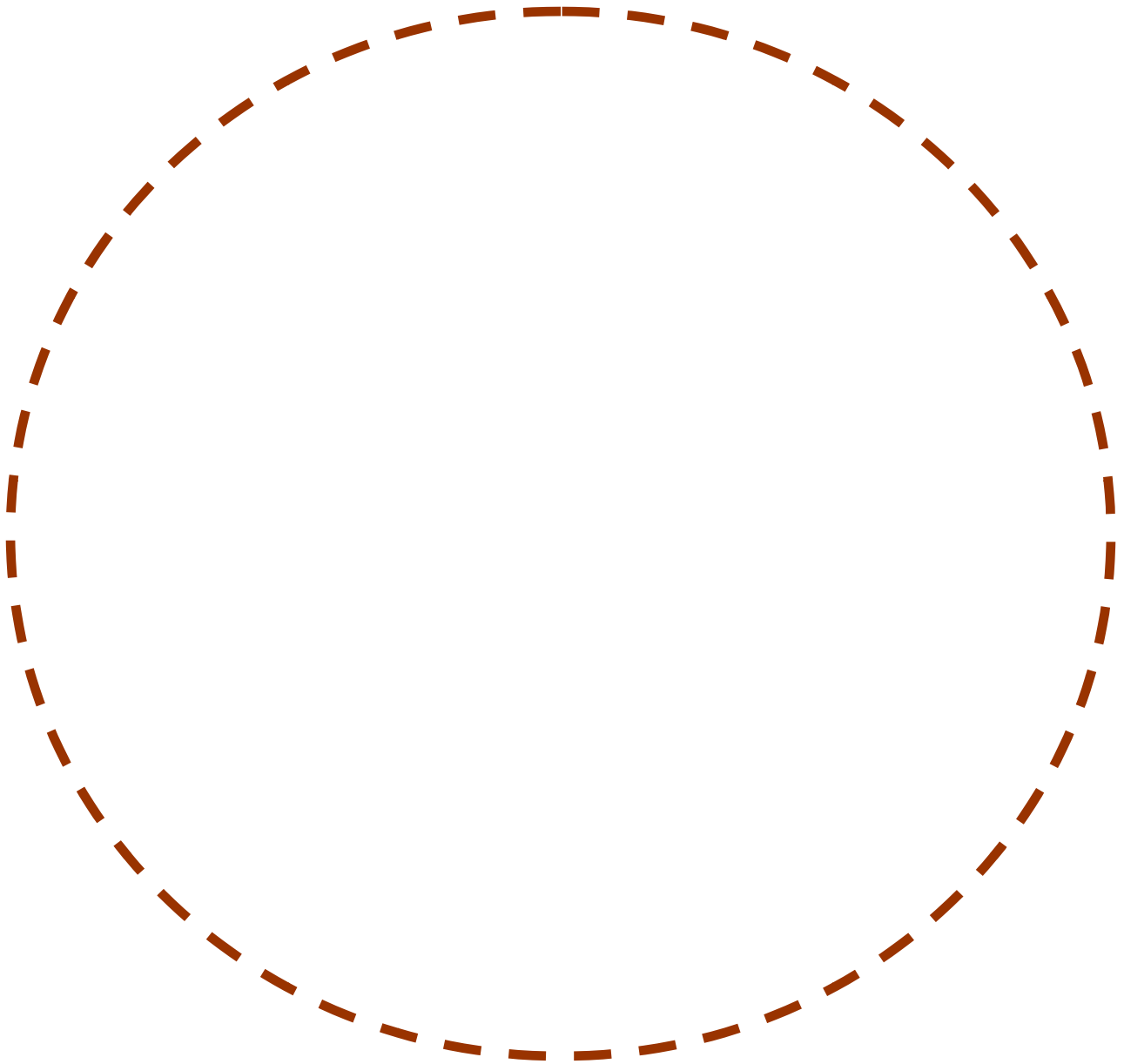

Adjectives = words that describe nouns = tells me something about the noun(s) = noun cargo

Articles Are Adjectives Too...

Adjectives = words that describe nouns = tells me something about the **noun(s) = noun cargo**

Articles = special adjectives

articles = adjectives

Articles and adjectives always tell me something about a **noun, so, I need to tie them to a noun on the sentence train.**

These are examples of **adjectives called **articles**...**

ARTICLES =

**a, an, the
all, every, none, some, this, that,
these, those**

Articles and
adjectives always tell
me something about a
noun, so, I need to tie
them to a noun on the
sentence train.

So far, my sentence train has three parts...

the engine = the verb

the conductor = the subject = noun(s)

the noun cargo = the adjectives and/or articles that go along with the noun

Example: The big, red, steam train stopped.

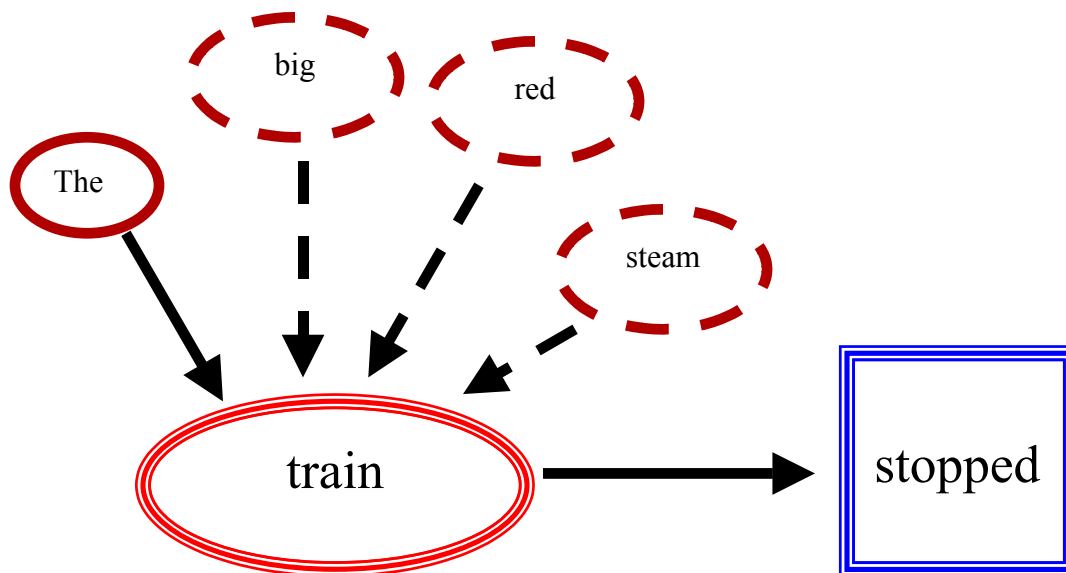

Note: The solid arrows show the main idea in this sentence.

Dashed arrows show “other parts” that are extra cargo in the sentence train.

Extra cargo is not critical to the main idea. These “other parts” are just “nice to have” because they give more details.

The big, red, steam train stopped.

In this example...

cargo tied to nouns and/or pronouns

= adjectives and/or articles

adjectives = The, big, red, steam

conductor = subject = noun = person, place or thing

subject = train

verb = stopped

**Putting all those words together gives me a sentence
or sentence train that says...**

The big, red, steam train stopped.

The big, red, steam train stopped.

Remember...

the sentence train conductor can also be a pronoun
a pronoun = word that takes the place of a noun

It stopped.

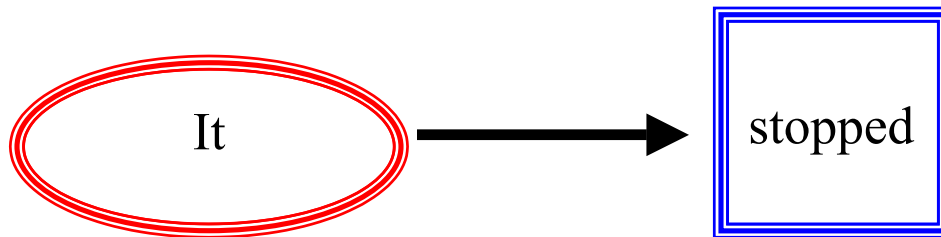

It = pronoun

“It” takes the place of “The big, red, steam train”

Adverbs...

**Adverbs = words that describe verbs, adverbs or
adjectives = verb, adverb or adjective cargo**

These are examples of adverbs ...

An Adverb tells me...

When... Where... How... How Often... To What Extent...

quietly, loudly, carefully, gently, badly, bitterly, happily, sadly, madly, richly,
poorly, dependably, reliably, unreliably, unbelievably, accurately,
inaccurately, violently, nonviolently, destructive, nondestructively, visibly,
invisibly, heavily, lightly, hurriedly, generously, greedily, selfishly, unselfishly,
aggressively, hungrily, sickly, jealously, beautifully, simply, shortly, weakly,
quickly, slowly, joyfully, playfully, respectfully, disrespectfully, rudely, politely,
uniquely, victoriously, wishfully, thoughtfully, silently, blindly, nicely,
excitedly, frantically, freely, delicately, intelligently, bravely, courageously,
lively, deadly, defiantly, sensitively, thankfully, calmly, expensively,
inexpensively, costlly, easily, hardly, warmly, coldly, tiredly, neatly, shyly,
outrageously, ridiculously, sensitively, constantly, lovingly, energetically,
powerfully, strongly, weakly, seriously, jokingly, urgently, casually, painfully,
pleasantly, smoothly, harshly, tightly, loosely, solidly, frequently, rarely,
nearly, practically, consequently, hence, here, there, everywhere, somewhere,
nowhere, sometimes, always, never, soon, hereafter, thereafter, thereby,
already, before, beyond, also, almost, as good as, as much as, much, somewhat,
not, so, very, too, quite, rather, tomorrow, today, yesterday, yet, still,
eventually, nevertheless, however, now, then...

and, there are many, many more adverbs too!

**Adverbs always tell
me something about a
verb, another adverb
or an adjective so, I
need to tie
them to a verb,
adverb or adjective
on the sentence train.**

**Adverbs tell me something
about...**

a verb

another adverb

an adjective

The little girl walked fast.

The little girl walked very fast.

The very little girl walked very, very fast.

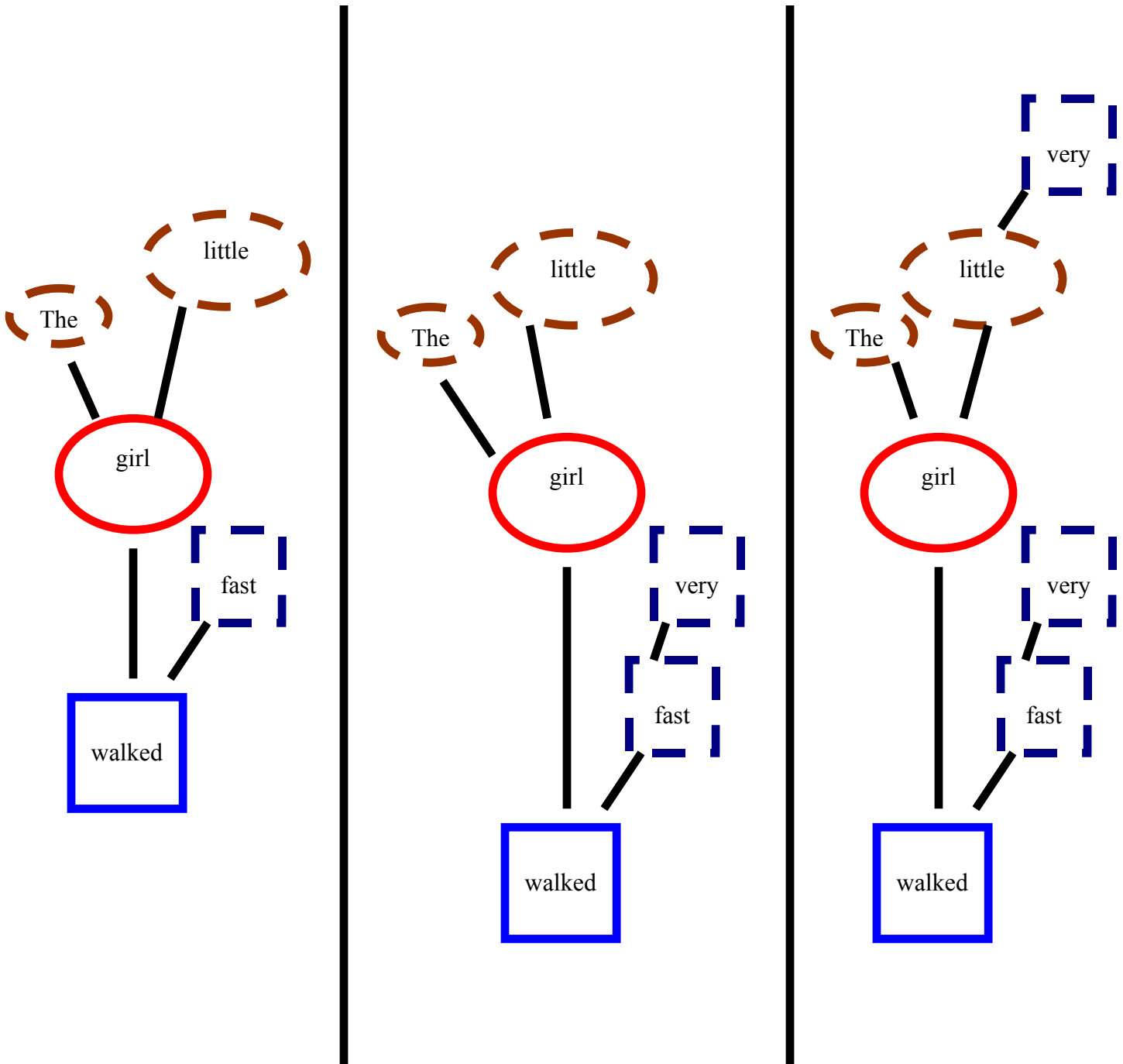

An Adverb Tells Me...

When

Where

How

How Often

To What Extent

I now need to put together all the sentence parts I have, so far, to make my sentence train.

The big, red, steam train stopped there, slowly.

subject = noun = conductor

verb = action word = engine

Adjectives and/or articles = noun cargo =

tell(s) me something about a noun

adjectives = tied to nouns

Adverbs = verb, adverb or adjective cargo

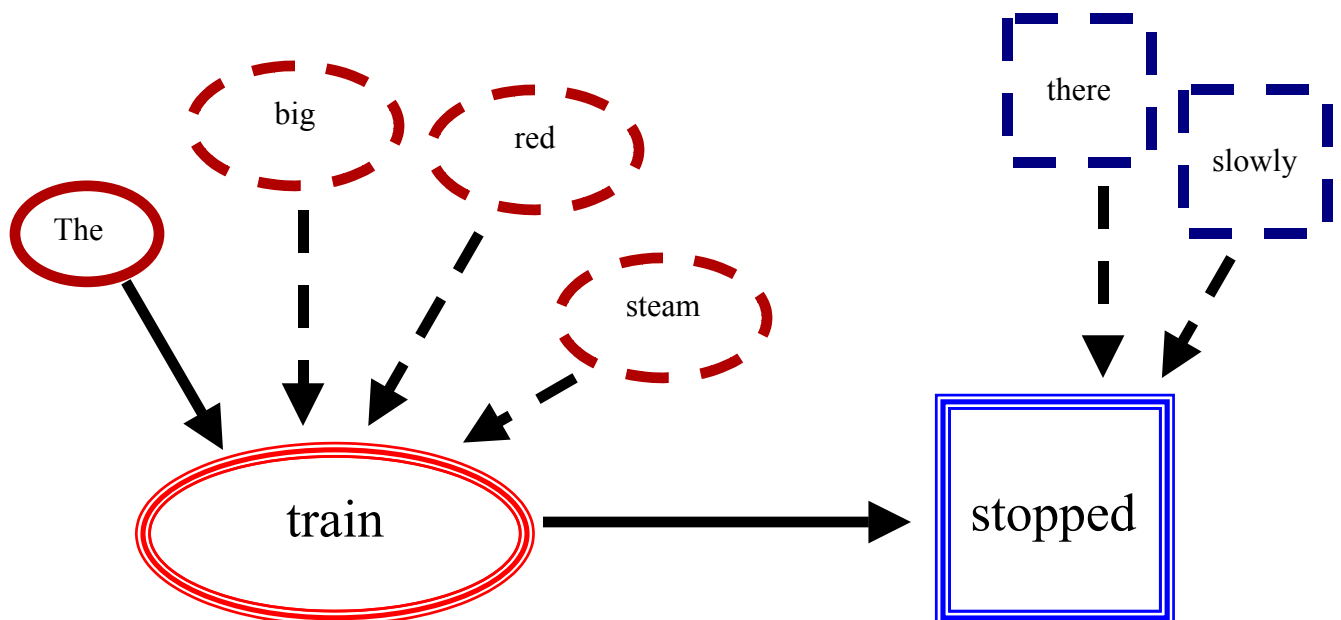

Conjunctions...

Conjunction = joining words = sentence train links

Conjunctions are words that tie together different train parts... so, they are “**train links**”...

I will put **conjunctions** in a “**plus sign**” to show that they put train parts together...

Conjunctions can be single words, a group of words or two words separated by other words “in between”...

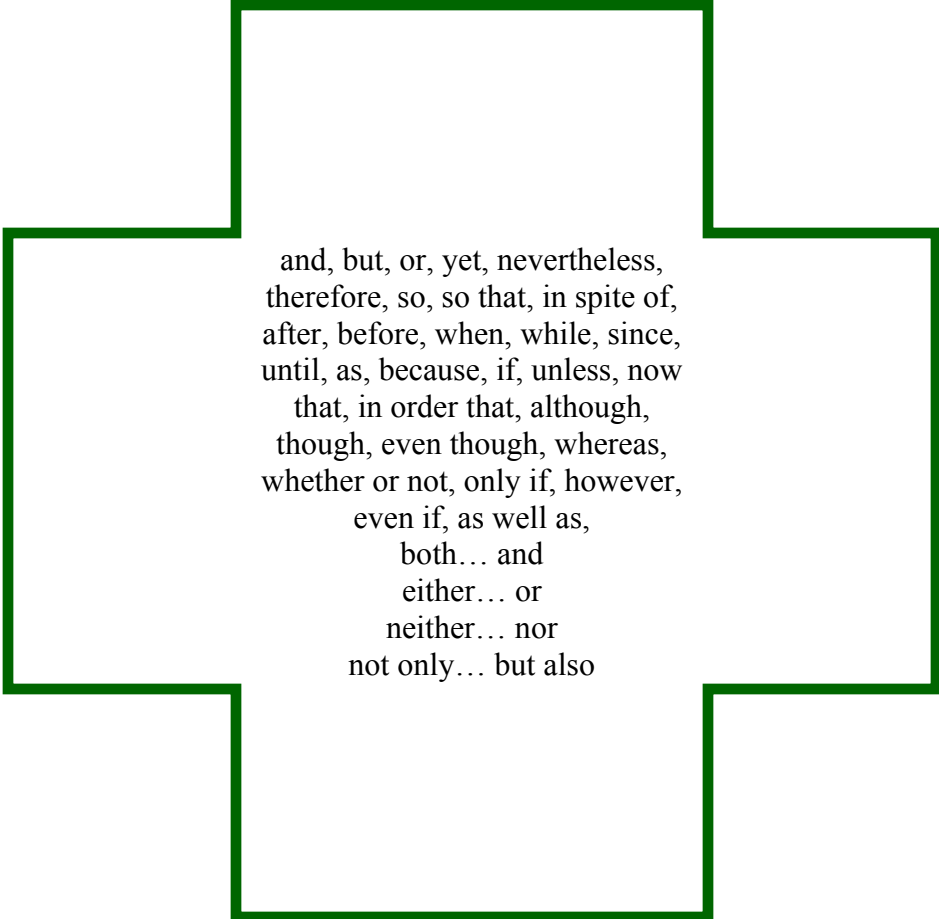

and, but, or, yet, nevertheless,
therefore, so, so that, in spite of,
after, before, when, while, since,
until, as, because, if, unless, now
that, in order that, although,
though, even though, whereas,
whether or not, only if, however,
even if, as well as,
both... and
either... or
neither... nor
not only... but also

Conjunctions...

Conjunction = joining words = sentence train links

Conjunctions Join...

Nouns

Pronouns

Adjectives

Adverbs

Prepositions

Phrases,

Etc.

I now need to put together all the sentence parts I have, so far, to make my sentence train.

Example:

The big, red, steam train stopped there, slowly, and reloaded carefully.

subject = noun = conductor

verb = action word = engine

Adjectives and/or articles = noun cargo =

tell(s) me something about a noun

adjectives = tied to nouns

Adverbs = verb, adverb or adjective cargo =

Conjunction = joining words = sentence train links

Example:

The big, red, steam train stopped there, slowly, and reloaded carefully.

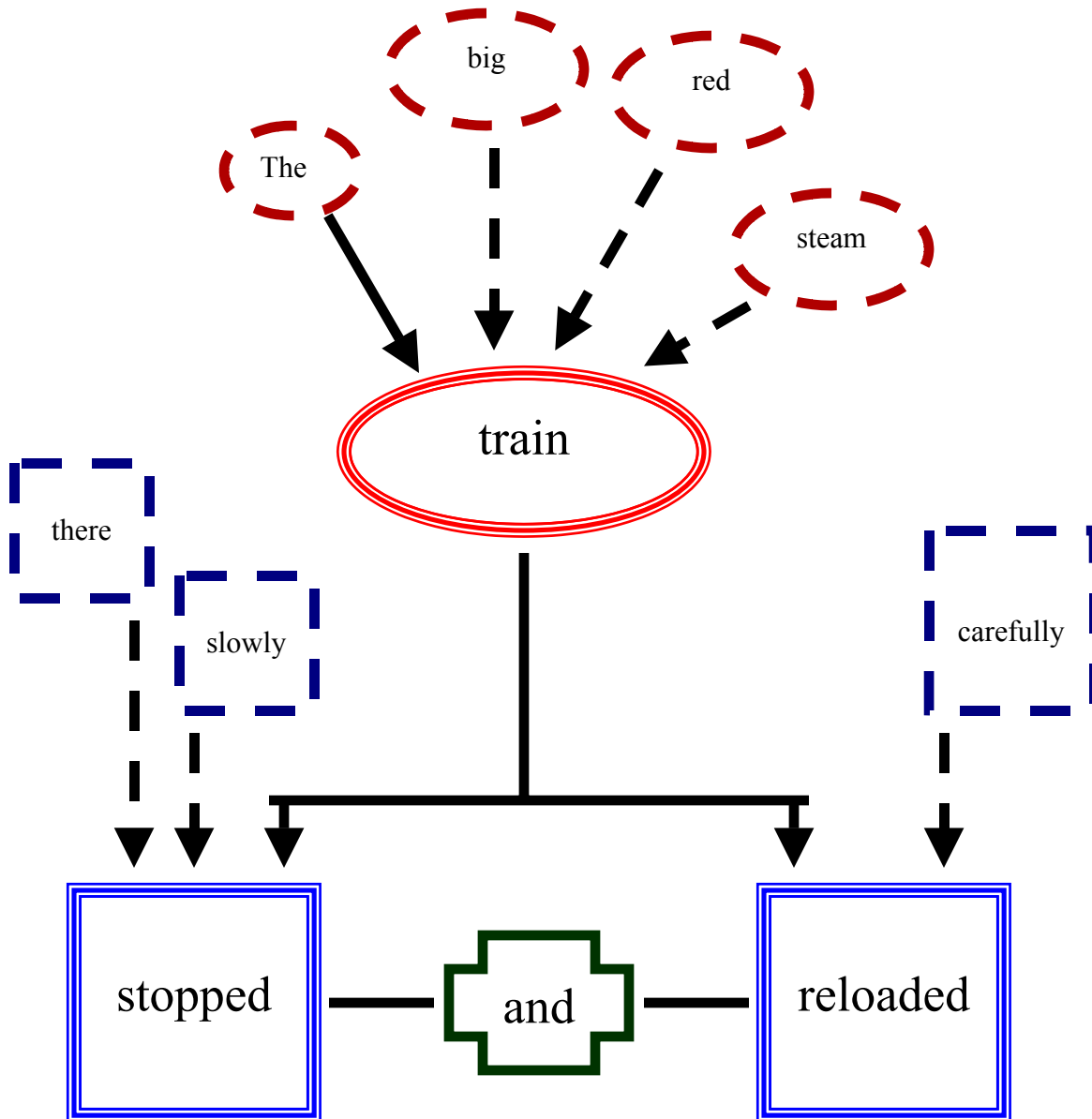

Prepositions...

Prepositions = words that work with other words to form a phrase

phrase = a group of words that express an idea or thought

Prepositional phrases are usually NOT the subject or verb of the sentence, so, they are “extra cargo” in the sentence and just tell me a little more information. Simple prepositions have just one word and complex prepositions have two or more words.

There are many prepositions... and they can be associated with nouns or verbs... so, I just have to listen to the phrase and see what word the preposition goes with...

These are examples of prepositions...

Prepositions include...

about, around, aboard, above, beside, besides, over, under, beneath, underneath, atop, below, behind, between, among, amid, along, across, beyond, against, before, during, after, since, until, in, out, into, onto, up, down, inside, outside, as, at, by, near, past, for, from, to, toward, on, off, of, with, without, within, except, but (= except), like, unlike, minus, concerning, considering, regarding, round, through, throughout, upon, despite, excepting, excluding, following, opposite, per, plus, save, verses, via, apart from, in spite of, because of, in view of, in addition to, by means of, contrary to, irrespective of, thanks to, in case of, in comparison with, in touch with, by way of, on behalf of, on account of, for the sake of, in exchange for, with reference to...

there are many others too!

Prepositions can be tied to **nouns**, **subjects** or **verbs**.

When I watch a train go by, I can usually see writing on all the train parts...

That writing can tell me the name of the company that owns the train.

That writing can also tell me what is in that train part... that is especially true if there is something dangerous, like chemicals, in the train car.

Each train car also has a special number on it to help the company find something fast. There can be many train cars that look the same and often, I can not see what is inside.

It would take a long time to find things if I had to open all the train cars.

The numbers on the train car help me know what is in that train car. They tell me something about that train car.

For example...

Train car no. 15 might have cars in it.

Train car no. 58 might have coal in it.

Train car no. 99 might have cows in it.

Train car no. 112 might have logs in it.

Train car no. 136 might have corn in it.

Train car no. 147 might have oil in it.

There can be many, many train parts on a train and so, to find things fast, it helps to have **labels for all the train parts.**

The train conductor and people at the train station have a list of all the car numbers showing what is in each train car.

So, the writing on the train cars provides a “label**” or “**description**” of what is in that train part.**

Prepositions or prepositional phrases are like “**labels**” found on the sentence train parts...

Remember:

a prepositional phrase is a group of words that starts with a **preposition**...

Like the train car numbers or “**labels**” on a real train, **prepositions** and **prepositional phrases** help me to know something about a sentence train part...

Prepositions help me to identify or understand that sentence train part a little more.

Because **prepositions** are usually part of a **prepositional phrase**, I will put those words together, in a rectangle, in my sentence train.

Here are a few examples of **prepositions and prepositional phrases** that help me “**identify**” or “**understand something more**” about a specific sentence train part....

The girl **in the house** was afraid **of the dog behind the fence.**

This sentence has 3 **prepositional phrases**:

“**in the house**” tells me something about “the girl”

“**of the dog**” tells me something about “what she was afraid of”

“**behind the fence**” tells me something about “the dog”

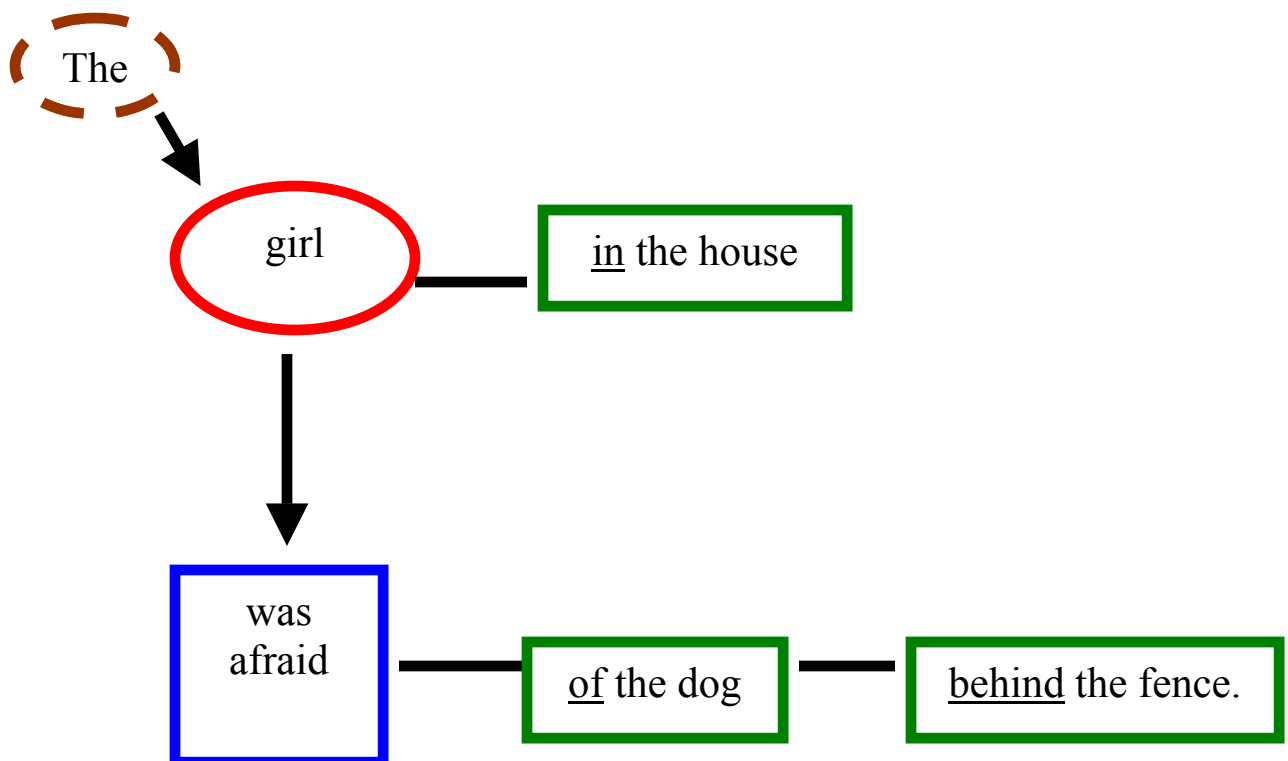

The terrible crash happened during the night.

“during the night” is a **prepositional phrase** that tells me something about “**happened**”

Remember: A **prepositional phrase** is a group of words that starts with a preposition...

That is why I keep the words of the **prepositional phrase** “together”.

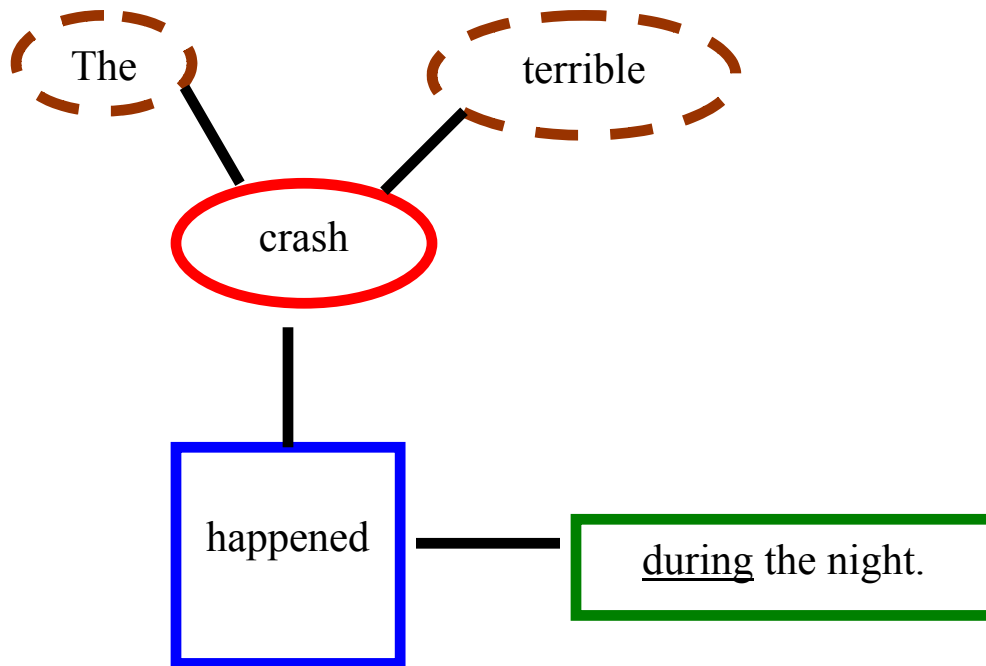

Note To Parents...

Just as prepositions can describe a noun, verb or direct object, there are some words that can “change jobs”, too. Some times, they can be articles, or adjectives, but at other times, they can be an adverb or direct object.

There are many such words...

The key to determining what a particular is always lies in determining what word(s) it relates to... with a little practice, this becomes much easier.

Example:

Many of the boys went to the store. (here, many is a pronoun and acts as the subject, “of the boys is a prepositional phrase).

The store had many boys in it. (here, it appears to act as an object of the verb – answering “had what?”)

They were many. (here it acts as an adverb).

It is important for parents to know this in order to “point out” the “role variations” you may encounter with your child...

Direct Object...

The **direct object** of the verb is the “**who**” or “**what**” the **action (verb)** is being “**done to**”.

To find the **direct object**, I just repeat the sentence and when I get to the **action word or verb**, I ask “**who**” or “**what**”. The answer will be the “**direct object**”.

The dog ate the bone.

The dog ate what? ... **the bone**

the bone = direct object of the verb

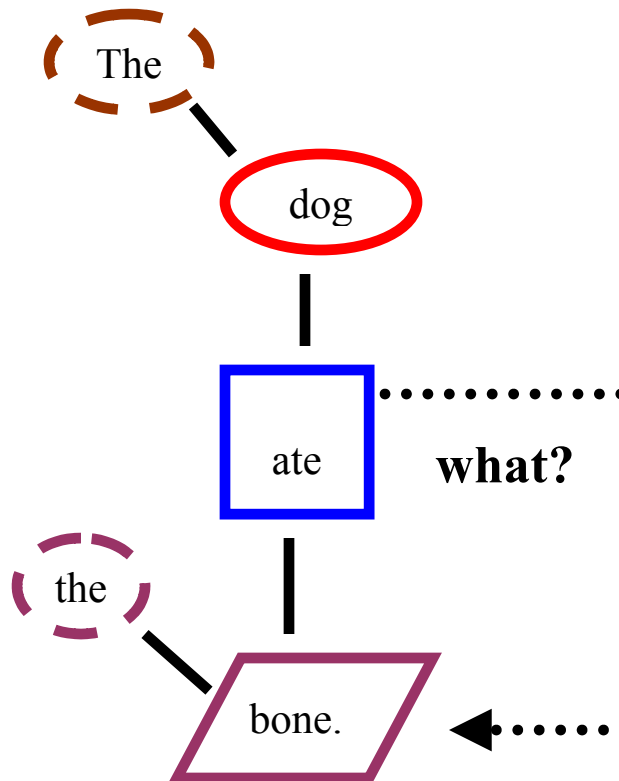

There are times when I can have more than one direct object...

I gave John the book.

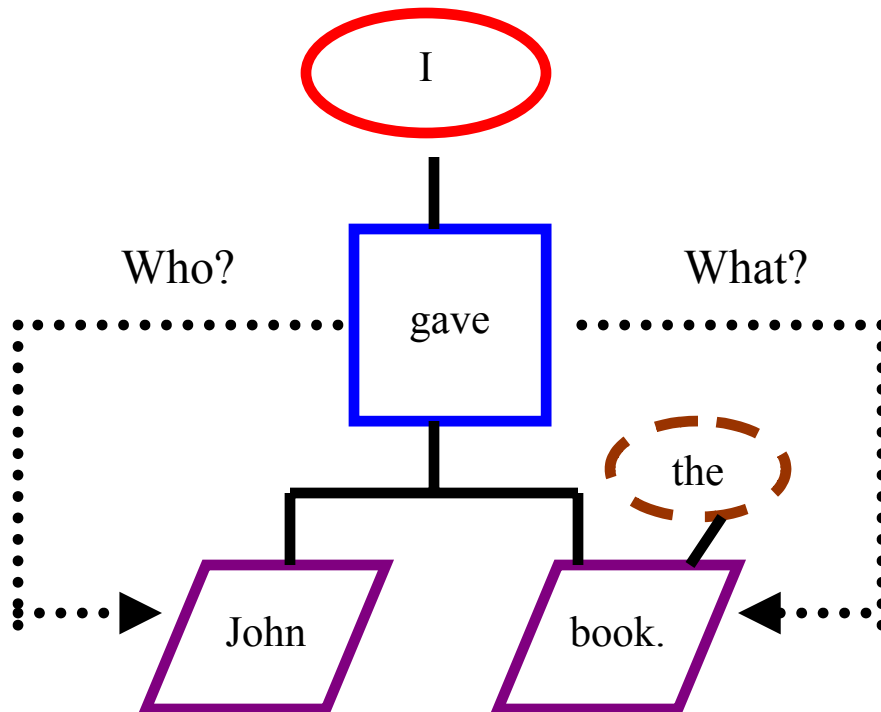

**The last part of a train is the caboose...
that is where the train stops...**

A sentence has a “caboose” too...

**The punctuation mark at the end of the sentence is the
sentence train caboose...**

**The punctuation mark shows me where the sentence
ends and so I will find it AFTER THE LAST WORD
in the sentence.**

**I can put the punctuation mark next to the last word
in my sentence train, or place it after that word in a
separate train car.**

Punctuation marks can look like this...

● = period

! = exclamation mark

? = question mark

there are other kinds too...

， = comma

； = semi colon

● = colon

Note: commas, semi colons, and colons are found in the sentence, but, not at the end of the sentence train. They are kind of like a “food or drink or restaurant cars” on the train...

They provide a place to “take a short break” or a place to “breathe in” when I am talking.

The sentence type tells me what kind of punctuation mark to use...

A “period” = “a dot” = “●” at the end of the sentence.

A “period” is the punctuation mark I will use most of the time.

A period just tells me that the sentence is finished and a new one is about to start.

A period is used with a “statement” type sentence.

Example:

John ate the apple.

My house is blue.

I love my mom and dad and they love me.

Swimming is fun if you like water.

An “exclamation mark” = 

I use an “exclamation mark” when the sentence shows
“excitement” or “sudden feeling”.

Here are a few examples:

Help!

Look at that!

Wow!

I can’t believe it!

Here they come!

Hooray!

No!

Yes!

A “question mark” = 

I use a question mark when the sentence is “a question” and I am asking someone something.

Questions usually start with one of these words...

Am	How	What
Are	If	When
Can	Is	Where
Could	May	Which
Did	Might	Who
Do	Must	Why
Does	Shall	Will
Had	Should	Would
Has	Was	
Have	Were	

When I see a sentence that starts with one of these words, it is probably a “question” and so, the sentence ends with a question mark... like this (?).

When asked a question, I am being asked to “give an answer to the question”.

There are many, many ways I can answer the very same question...

Here are a few examples of questions and answers...

Question **What is your name?**

Answer **My name is Zachary Brohart.**

or **My name is Zachary.**

or **I am called Zachary.**

or **Zachary.**

or **Zachary Carl Brohart.**

Question **Where do you live?**

Answer **I live in Michigan in the United States Of America.**

or **I live in Michigan.**

or **I live in a house.**

Question

When do you go to bed?

Answer

I go to bed at 8:00 pm.

or

I go to bed at 8.

or

I go to bed when I am tired.

or

I go to bed when mommy or daddy says it is time for bed.

or

I go to bed when it gets dark outside.

Question

How are you?

Answer

I am fine, thank you.

or

I am fine. How are you?

or

I'm tired.

or

I'm happy.

or

I'm doing ok.

or

This is one of **my best days ever!**

or

I've never felt better!

or

I'm great!

Question

What do you like to do?

Answer

I like to play.

or

I enjoy reading.

or

I really like playing on the computer.

or

There are many things I like to do. Walking, playing, talking, dancing and swimming are just a few of the things I like to do.

or

I like eating new things.

or

When it is nice out, I like to play outside. If it is raining, I like to paint or draw on paper inside my house.

or

I love playing with my dog or my cat.

or

I love teasing my sister.

Question

Is that your cat?

Answer

No.

Or

No. It's not my cat.

Or

No. I don't know whose cat that is.

Or

No, it isn't mine, but it sure is cute.

Question	What time is it?
Answer	It is time to go.
or	It is time to eat.
or	It is 3 o'clock.
or	It's time for school.
or	It's time for bed.
or	It is time to play.
or	It is time for work.
or	I don't know what time it is.

So, there can be many, many answers to the same question.

The answer just depends on the situation and what I am doing when someone asks me a question...

The answer also depends on “who is asking” the question...

It is ok to answer some people one way... but not another...

My mom or dad can teach me “the right way to answer” for “different person”...

Note To Parents...

I always try to encourage Zachary to give me “more answers” to the same question when working with him in order to help increase his flexibility and/or variety of speech.

I’m just starting in doing this, but, already, I see Zachary understanding that there can be “many answers” to the same question – and that is exactly the concept I am trying to teach him and that I knew he did not understand well in the past. :o)

When someone asks a question, they want an answer to that question... and the answer is not the same as the question...they are different!

There are many ways to answer a question...

The key is to “listen” to the question and see “what” the person asking the question wants to know.

There are ways to know what the answer is for a question...

These are a few hints...

The key is to pay special attention to the first word in the question...

The answer to...

“Who” questions = a person

“What” questions = a thing

“When” questions = a time

“Where” questions = a place

“Why” questions = a reason = “because”

“How” questions = a way

Who = a person

What = a thing

When = a time

Where = a place

Why = a reason

How = a way

These are the most common question types ...

**and once I know how to answer one question, I
can pretty well understand and figure out most of
them...**

I must always remember:

**There are many ways to answer the same
question or to say the same thing!**

There are many ways to say the same thing...

Hello.

Hi.

Howdy.

How are you?

**Hello. = Hi. = Howdy. = How are you? = different ways to say
“Hello”.**

Goodbye.

See you later.

Come back soon.

See ya.

Bye.

Good night.

Good day.

**Goodbye. = See you later. = Come back soon. = See ya. = Bye. =
Good night. = Good day. = Different ways to say “goodbye”.**

In math, I can find many ways to come up with the same answer.

For example, there are lots of ways to equal “8”...

8	+	0	=	8
7	+	1	=	8
6	+	2	=	8
5	+	3	=	8
4	+	4	=	8
3	+	5	=	8
2	+	6	=	8
1	+	7	=	8
0	+	8	=	8

I can also find different ways to say the same thing when I am talking... and that is true for pretty well everything I say.

So, just like in math, there are many ways to talk and still say the same thing!

Note To Parents... A Word Of Caution...

In working with Zachary, I soon came to realize that he was confused by the questions:

What is your name? and Who are you?

I saw a couple of issues here...

First and foremost was the issue with “pronouns”... see my pronoun section for more on that...

The answer to both questions was “Zachary”... but, “what” is a “thing” and so, if I asked Zachary other “what questions”, at first, he started to answer “Zachary”... thinking all “what questions” had the same answer... and he associated the prompt - “what” - with an answer of “Zachary” – especially if he was very tired. “What is your name?” was one of the first things I worked on with him – long ago - and as such, that had built that “first word association” for “what questions”. “What” – to Zachary – was strongly associated with the answer “Zachary”. Much as “sit up, please” had resulted in an almost automatic response of “stand down, thank you”, so did “what questions”, initially, result in an almost automatic “Zachary” answer.

Correcting Zachary – and providing “the correct response for him” by actually telling him “what to say” was the key to overcoming this because it allowed him to eventually see that there were “other answers” to “what questions”.

This had been a difficult concept for Zachary since “what is your name” was such a common question on my part initially as I had tried to teach him his name so long ago. But, now, I realized the many issues behind communication – especially when it came to “word associations” and as such, I saw this particular issue had several “traps” in it.

I knew there was another reason Zachary had been confused by this. The answer to “What is your name” is – a thing – “a name”, but, in this case, it also is an answer to “who” and Zachary had a difficult time with that.

A name = thing = “what”

A person = who

“what” does not usually = “who” and as such, in this instance of “a name” it was important Zachary understand that the “what” was “his name” and not “who” he was because “who” was indicative of “a person” – not a thing!

Now that Zachary had a better understanding of language, this issue had greatly subsided, but, every once in a while, I still see it pop up and so, I wanted to raise it for parents.

Just something to keep in mind and to watch for...

Note To Parents...

Questions are a little harder to put in bubble graphs.

In a question, the words not only get “moved around” but they also change (i.e., verb tense, role, etc.).

As such, I do not plan on attempting to “graph” questions with Zachary. I may do a few here and there, but, personally, even I found it challenging to graph a question. As such, I did not go into much detail when it came to “graphing questions in these materials. All I wanted to do was introduce Zachary to the idea that with “a question”, the words “move around”.

When you started to look at “questions”... it was easy to see how quickly they became difficult to graph. Take for example the following:

I was going to the store.

Was I going to the store?

This is a simple sentence to graph as “a statement” or “an exclamation”... but, as a question, it becomes more complex... because the verb gets “split apart”... and so you need to actually make 2 verb boxes... even though as a statement or exclamation, you can easily just include the helping verb in the box with the primary verb.

Needless to say, this is not a level of difficulty Zachary – or I - needed to get into at this time... If he asked me to graph a question, I would attempt to do so, but otherwise, I planned on staying away from graphing these – at least for now.

I provided an example on the following page... but, honestly, I was not 100% sure as to whether or not it was correct. I simply wanted to provide the “concept” that words change around when we use questions in speech.

So, if my next example is incorrect, I apologize for that... and encourage any grammar expert out there to let me know the correct way to graph this question. Actually, a few examples would be greatly appreciated... I could then put them in these materials as updates under Parent Teaching Tools. :o)

Just as there are different kinds of trains... like a steam train, an electric train or a diesel train... there are different types of sentence trains, too!

There are 3 primary sentence types:

- 1. A statement**
- 2. An exclamation**
- 3. A question**

Statement: The house is blue.

Exclamation: The house is blue!

Question: Is the house blue?

Now let's look at the bubble graphs for these different types of sentences...

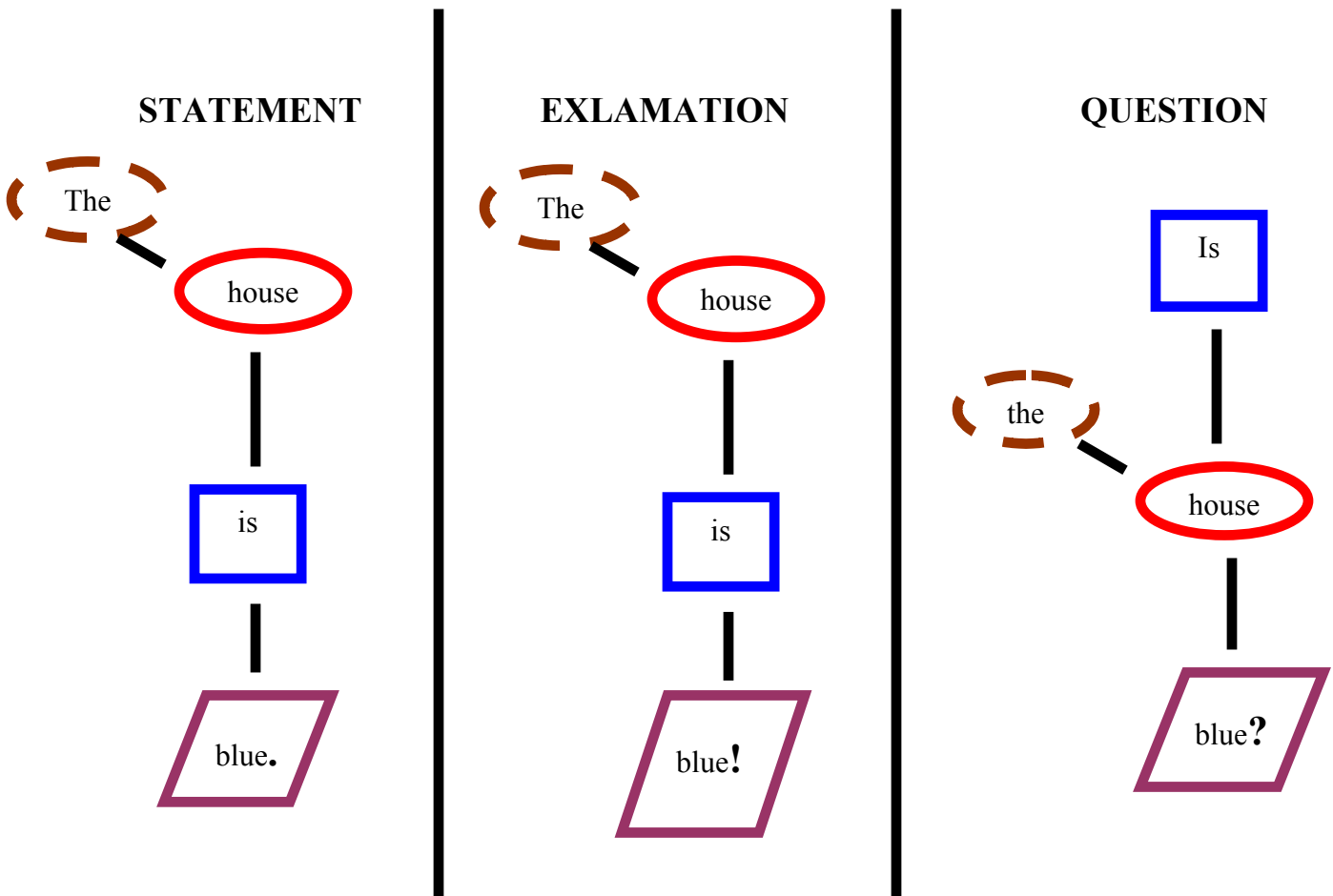

The following pages provide practice bubbles graphs...

I can use the word lists provided for articles, adjectives, nouns, verbs, adverbs, conjunctions, prepositions, and contractions to help me build sentence trains...

I can also use onomatopoeias and compound words to create fun sentences.

I will make a sentence with just one word...

Remember: When a sentence has just one word, it is usually a **verb!**

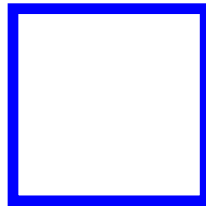

I will make a sentence that has a subject and a verb...

I will use my name as the subject...

Then I will try making the same sentence using a pronoun to take the place of my name...

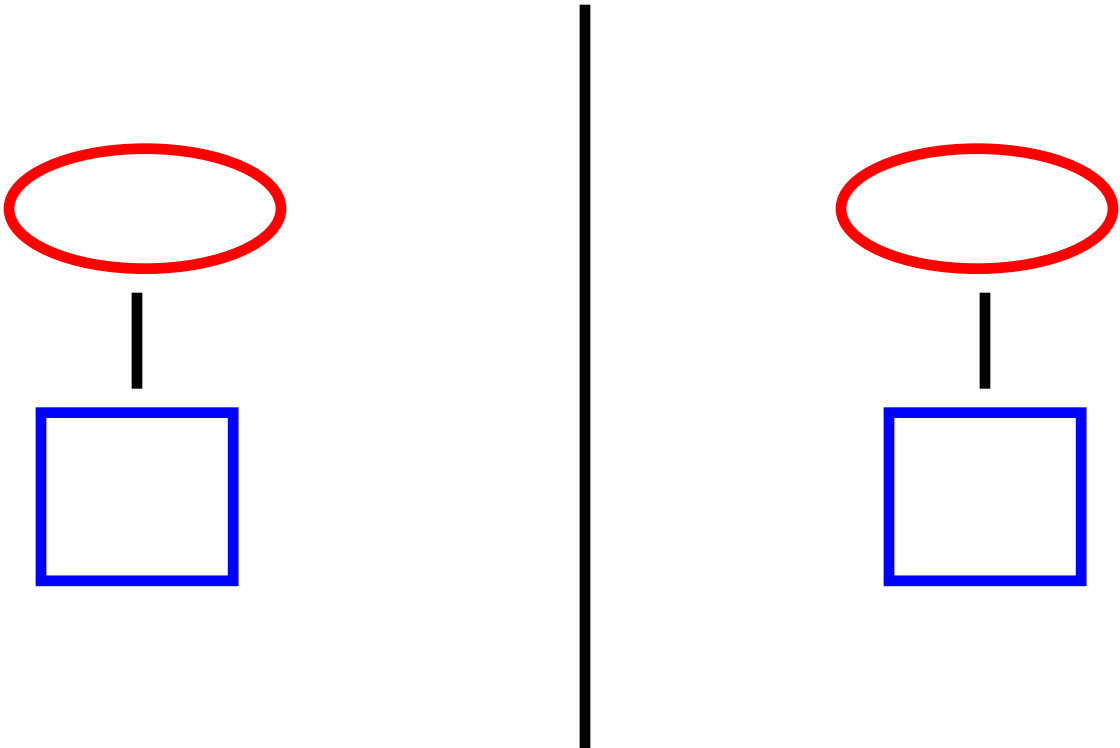

I will make a sentence that has an article, a subject and a verb...

Then I will try making the same sentence using a pronoun to take the place of the subject...

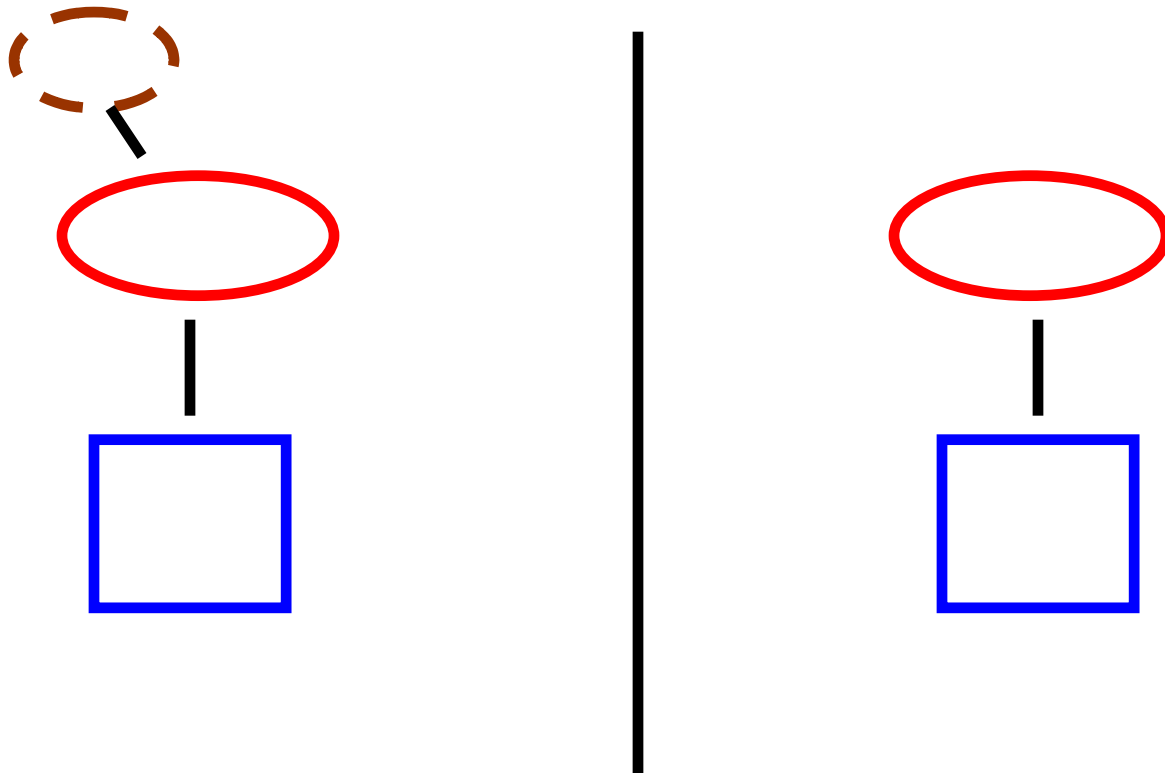

Now, I will make a sentence with an article, an adjective, a subject and a verb...

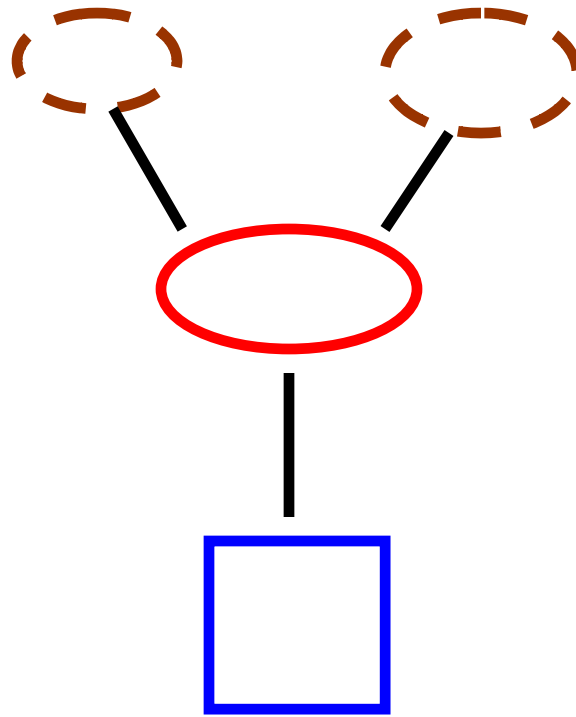

I will write a sentence with an article, adjective, subject and verb and then write the sentence using a pronoun instead as the subject...

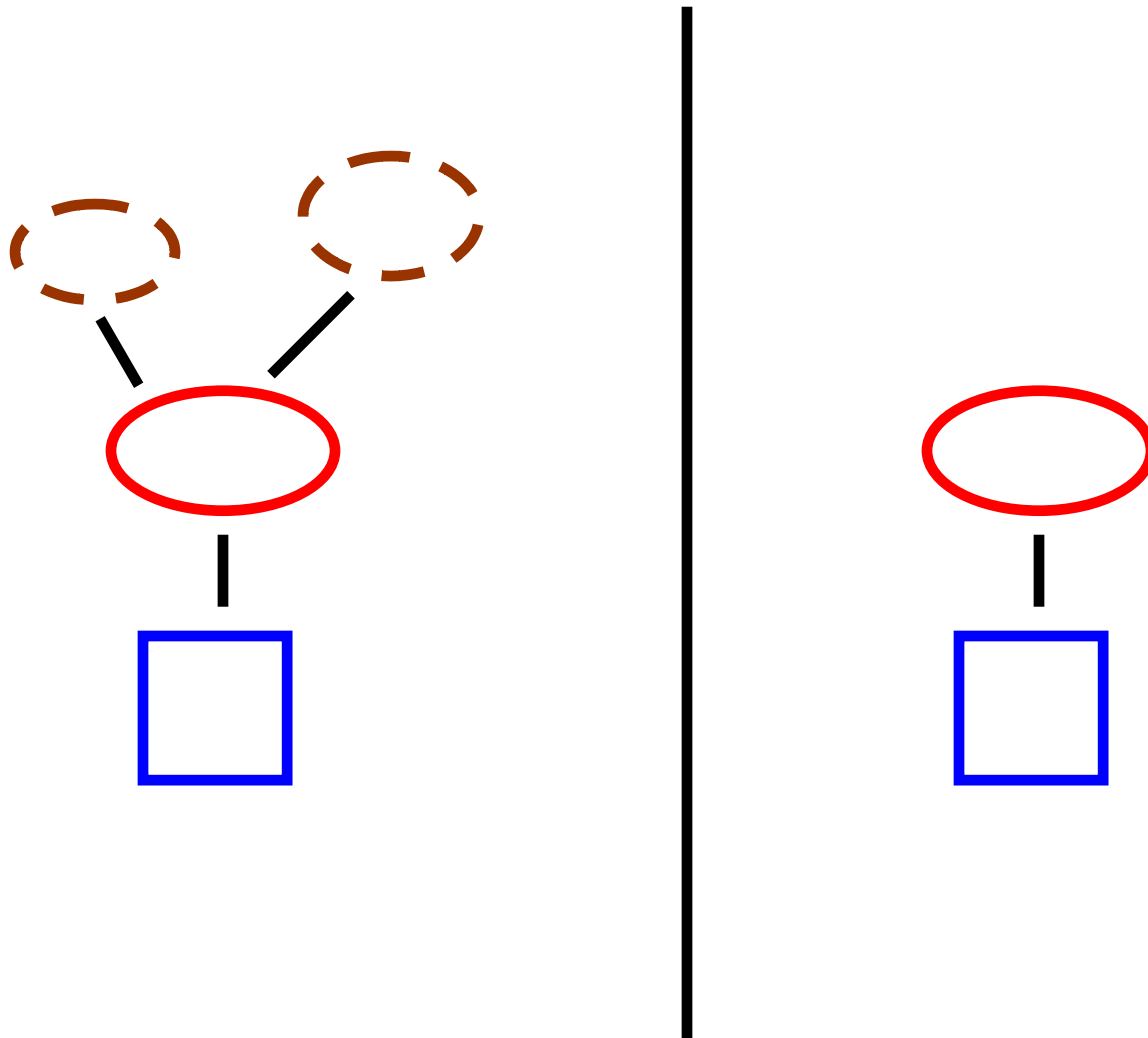

I will write a sentence with an article, adjectives, a subject and a verb and then, write the same sentence using a pronoun...

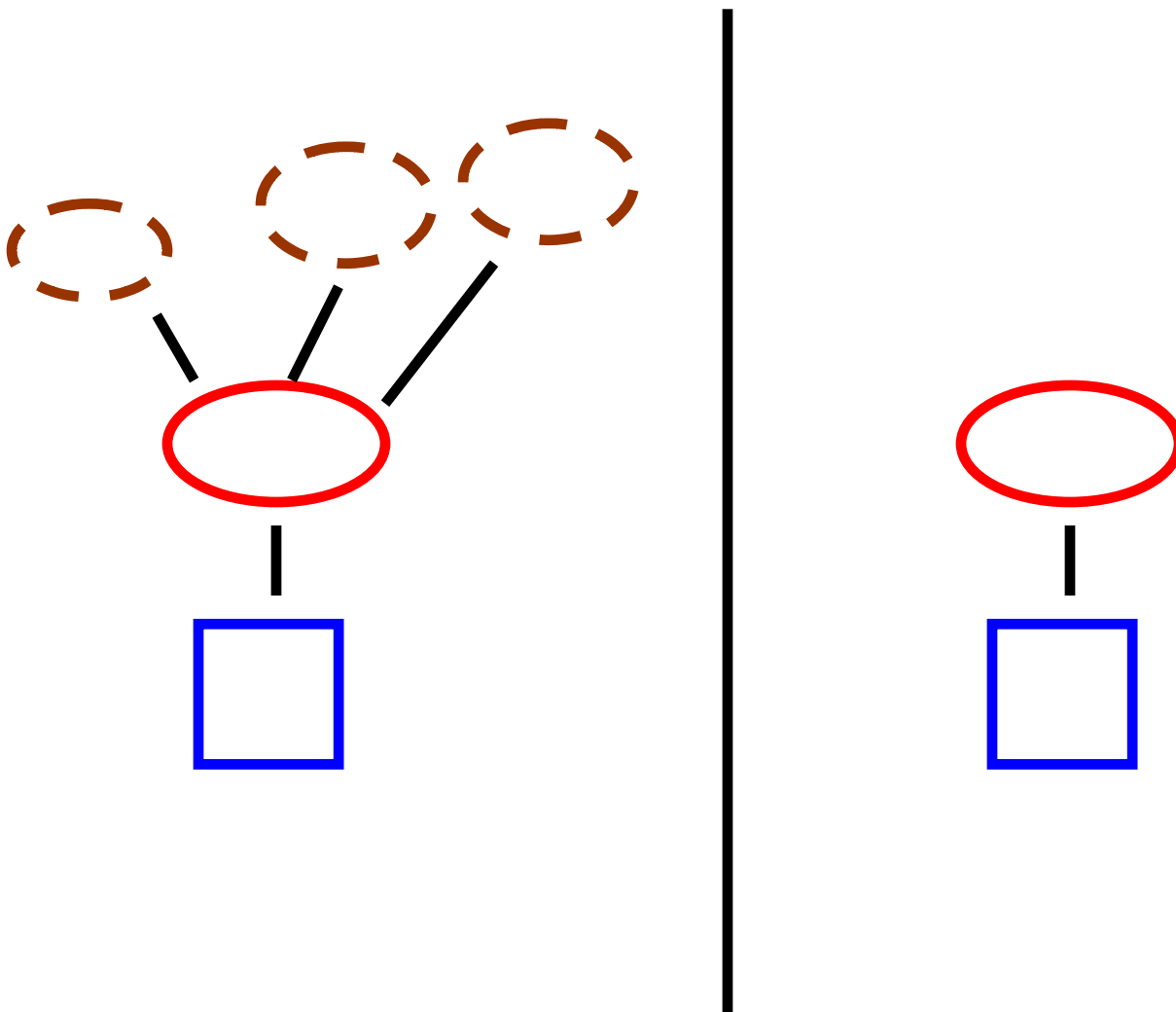

Now, I will add in another adjective...

Note: I can see that it does not matter how many more adjectives I add in... the sentence stays the same when I use a pronoun as the subject...

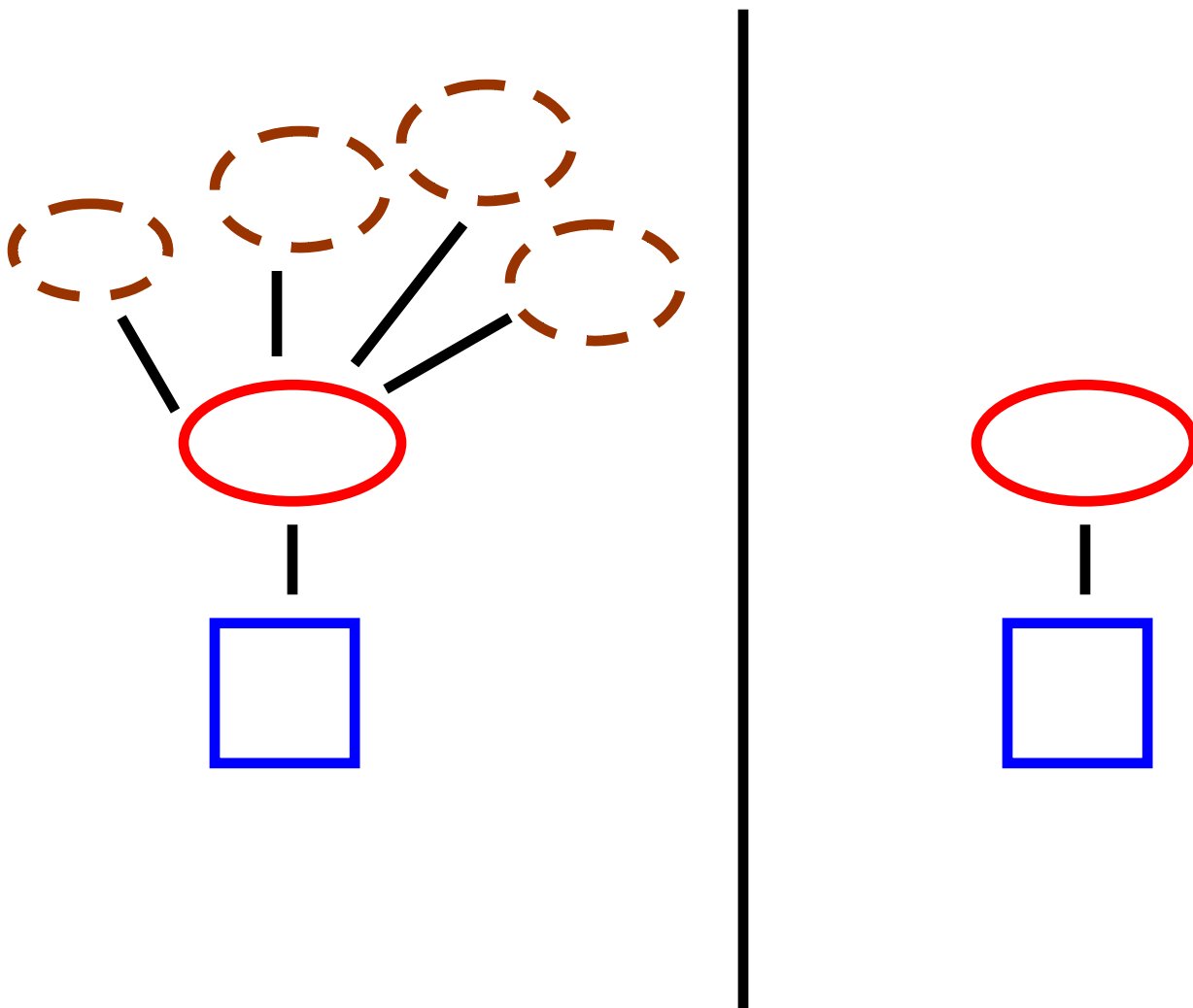

Now, I will add in another subject and join the two subjects with a conjunction.

In this sentence, I will use my name and the name of someone I know as the subjects.

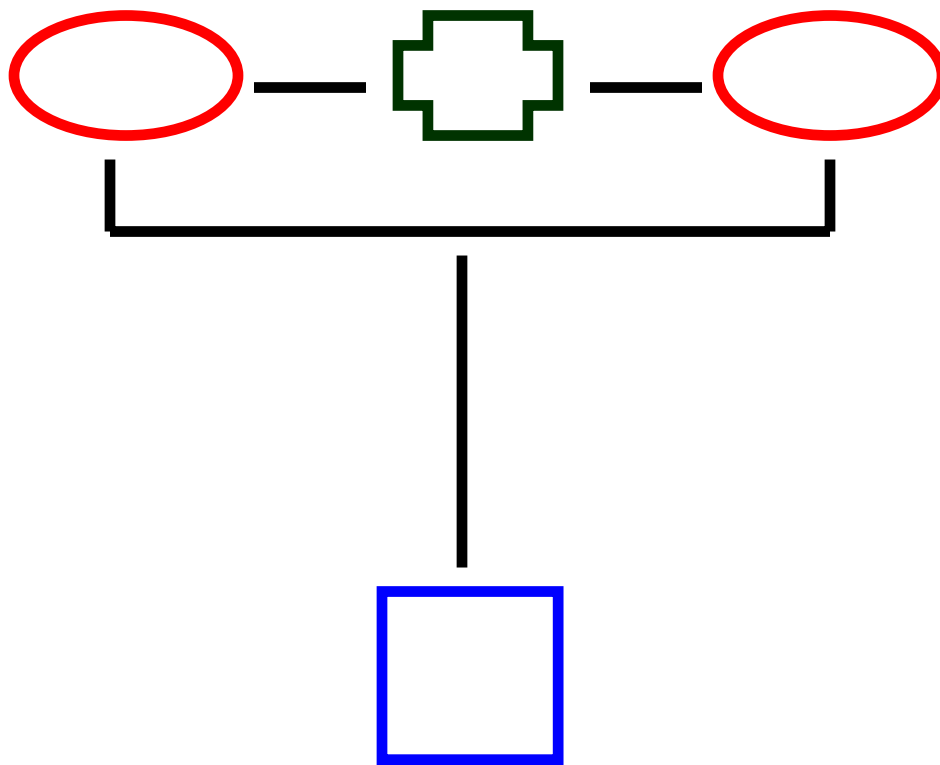

**I will write a sentence with two subjects and one verb.
I will join the two subjects with a conjunction and then
write the same sentence using a pronoun to replace the
subject information...**

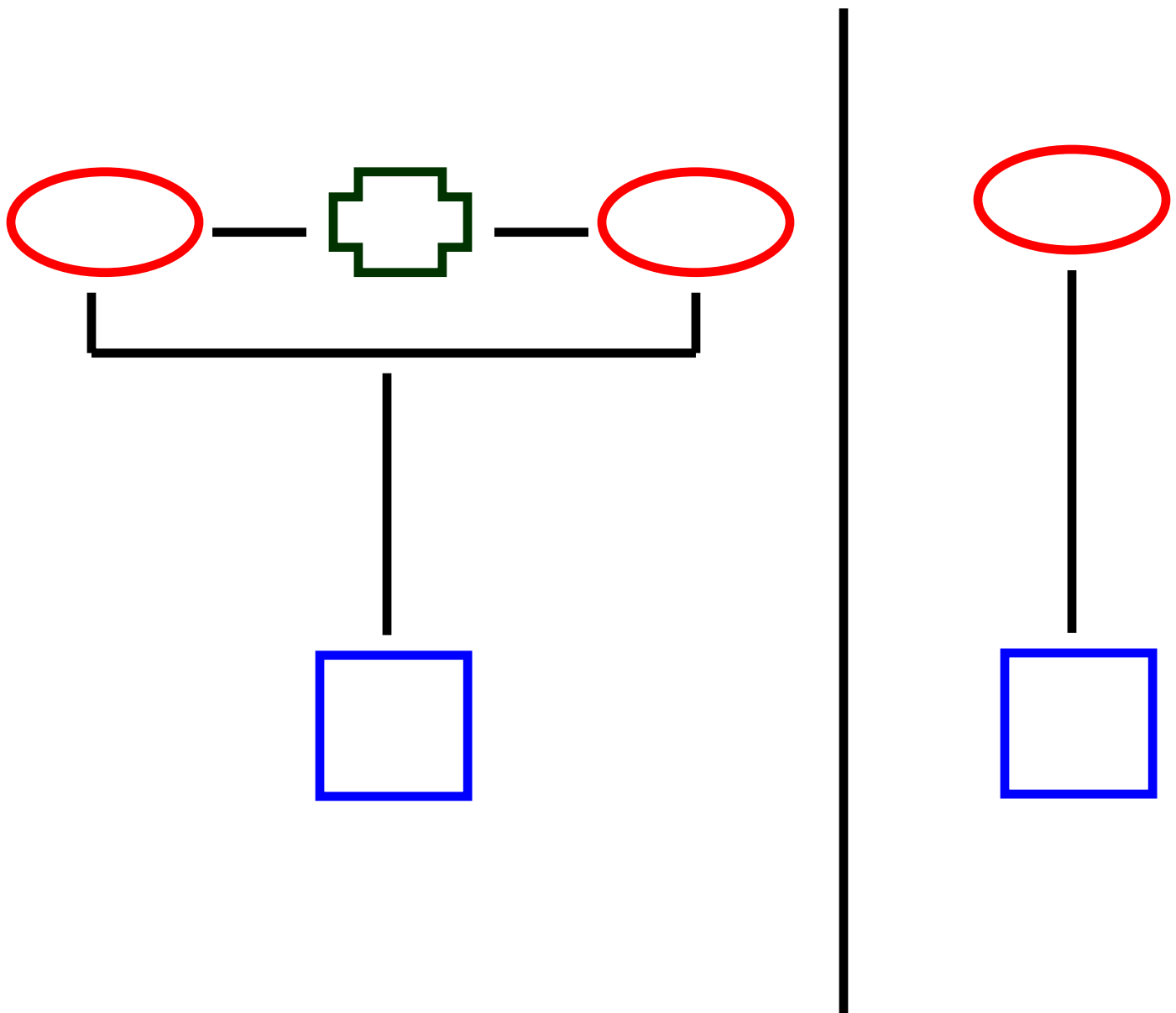

I will write a sentence with two subjects, two articles and a verb and join the two subjects with a conjunction.

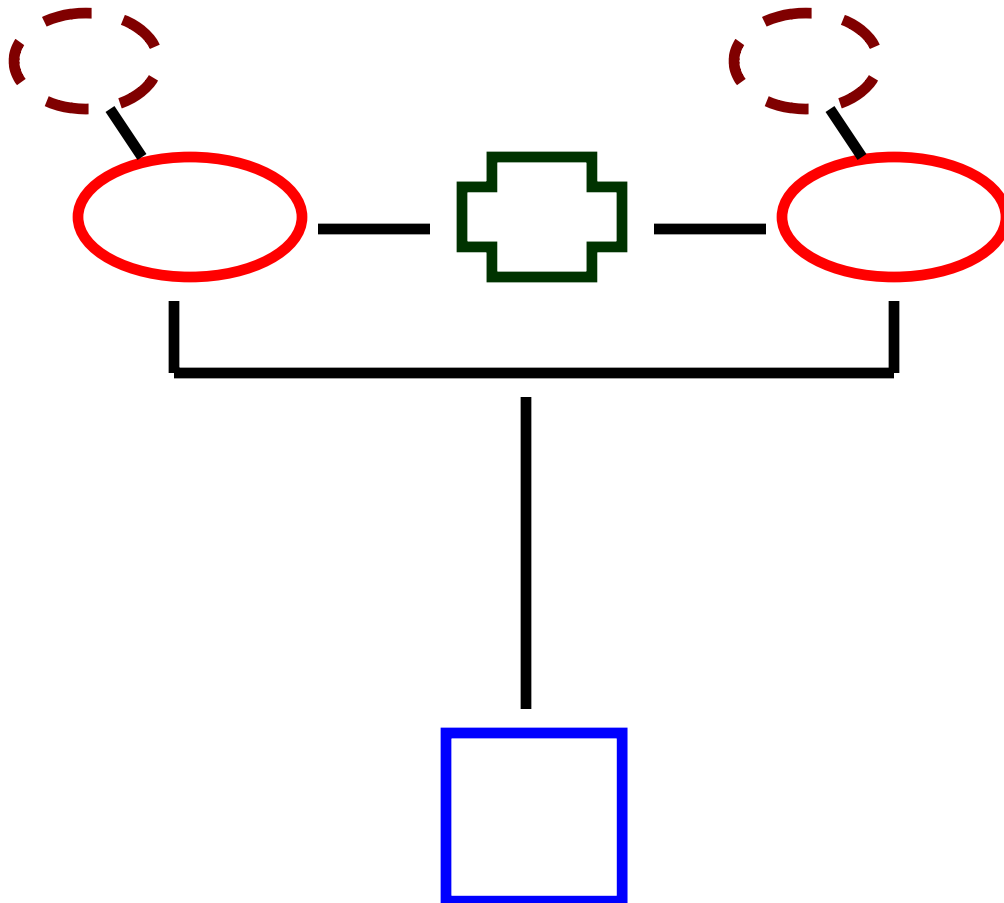

I will write a sentence with three subjects, one conjunction and one verb... and then, write the same sentence using a pronoun to take the place of all subjects...

I will use my name and the name of two other persons in this sentence...

I can see that adding another subject does not change the sentence using a pronoun.

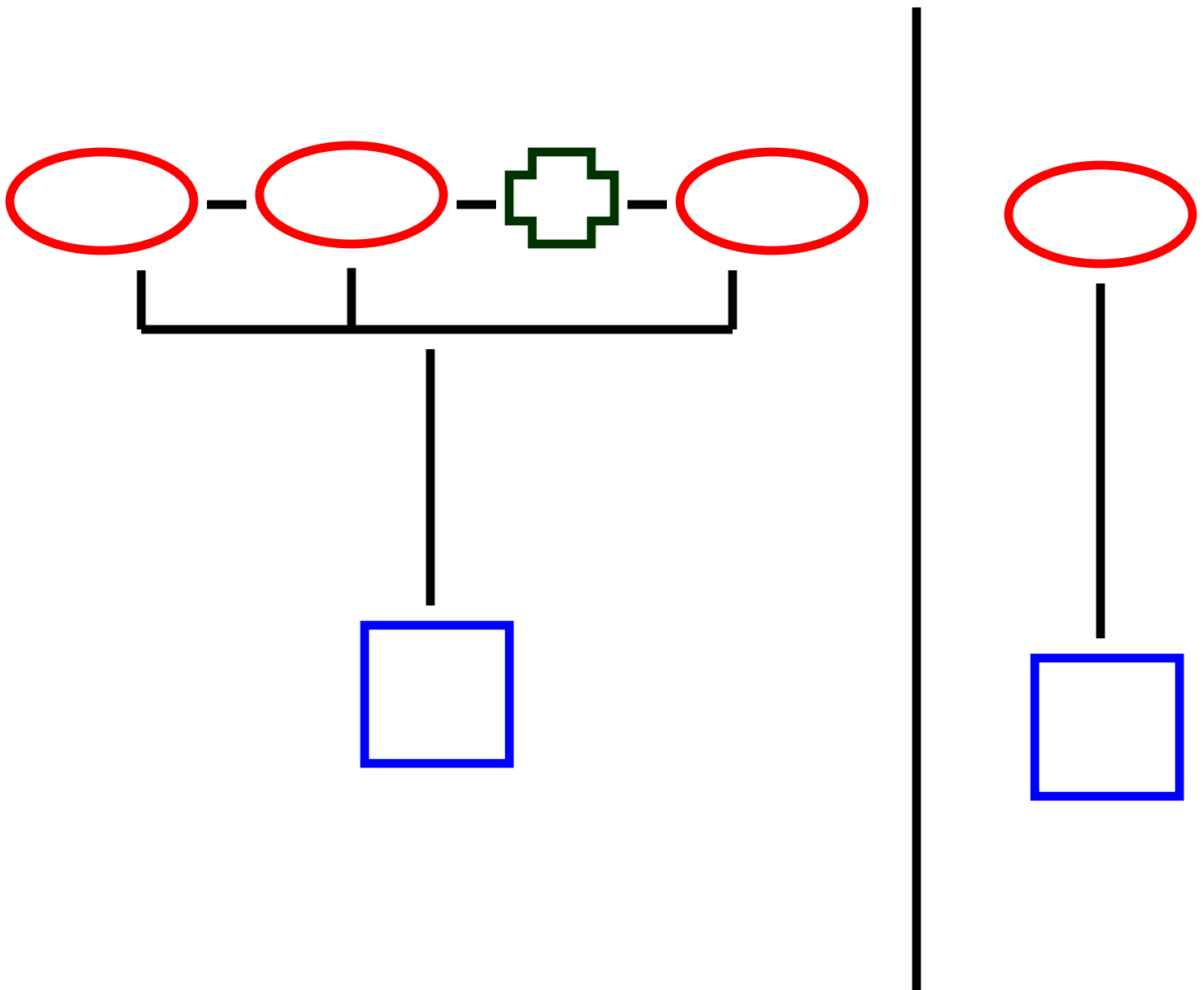

Now, I will write a sentence using three subjects and I will add in some articles and adjectives...

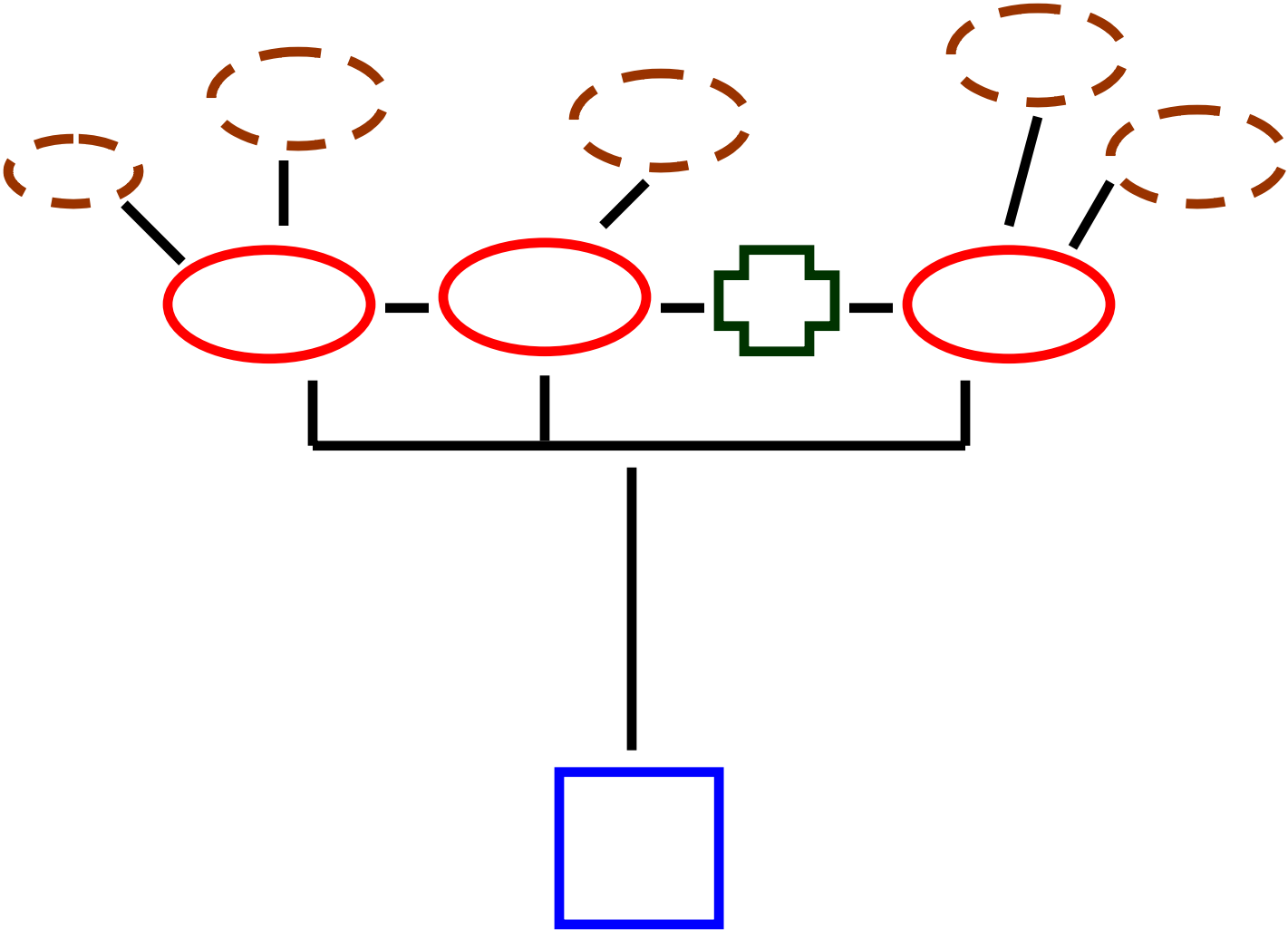

I will write the a sentence and then replace the subject information with a pronoun...

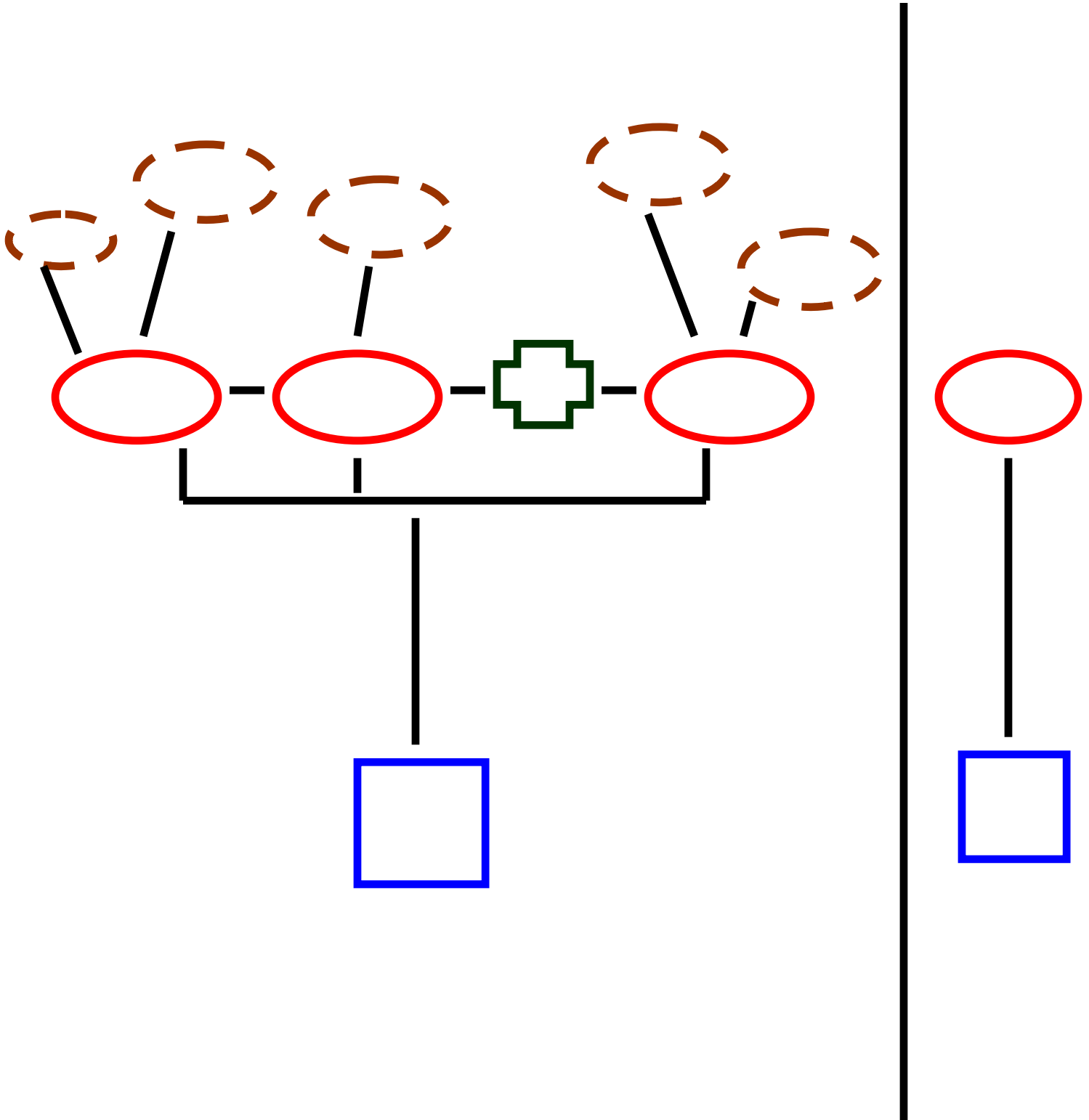

**In this sentence, I will add in a prepositional phrase...
and then write the same sentence using a pronoun to
replace the subject information...**

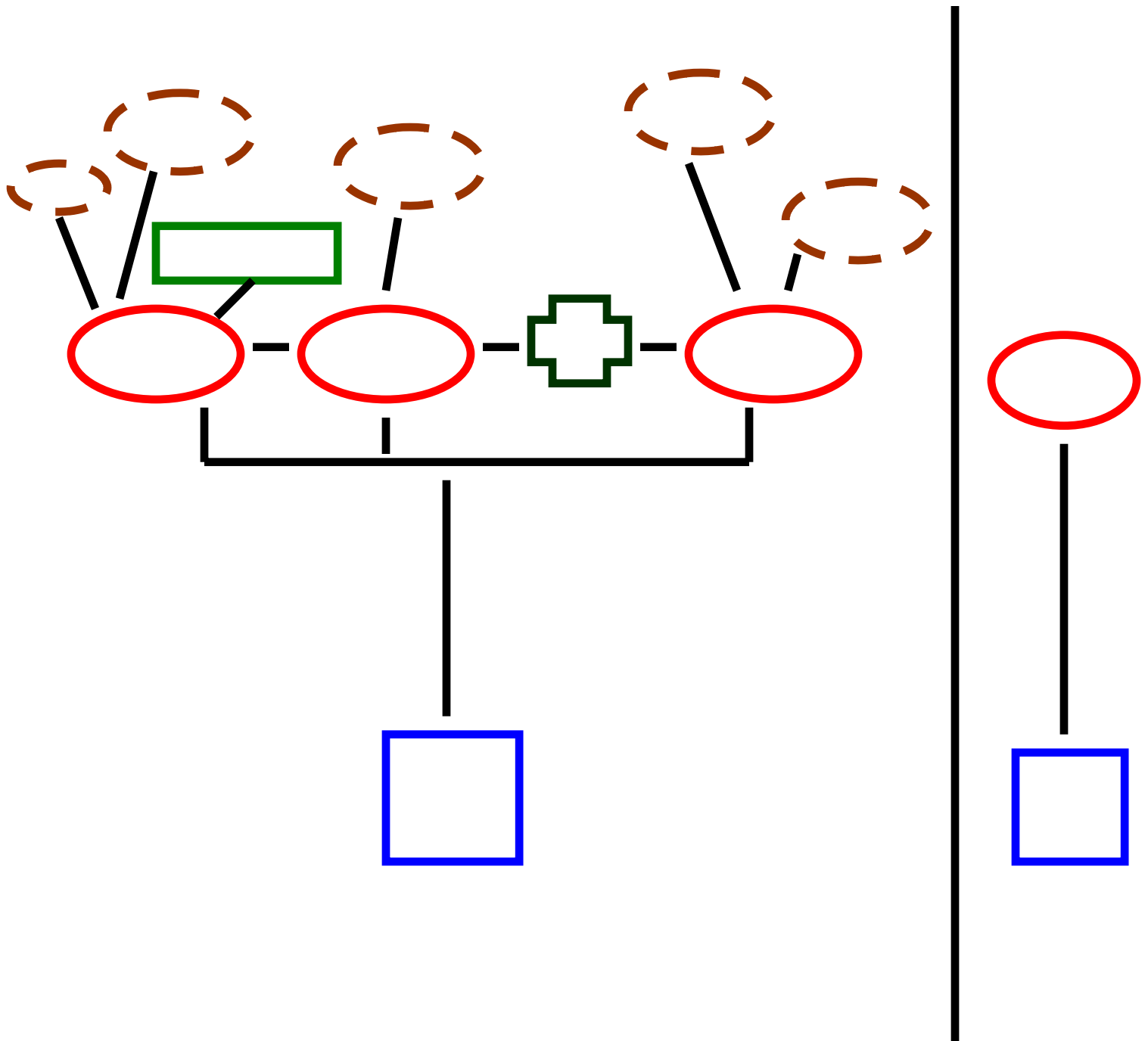

I can add in more prepositional phrases... and see that when I use a pronoun... one pronoun can take the place of all that subject information...

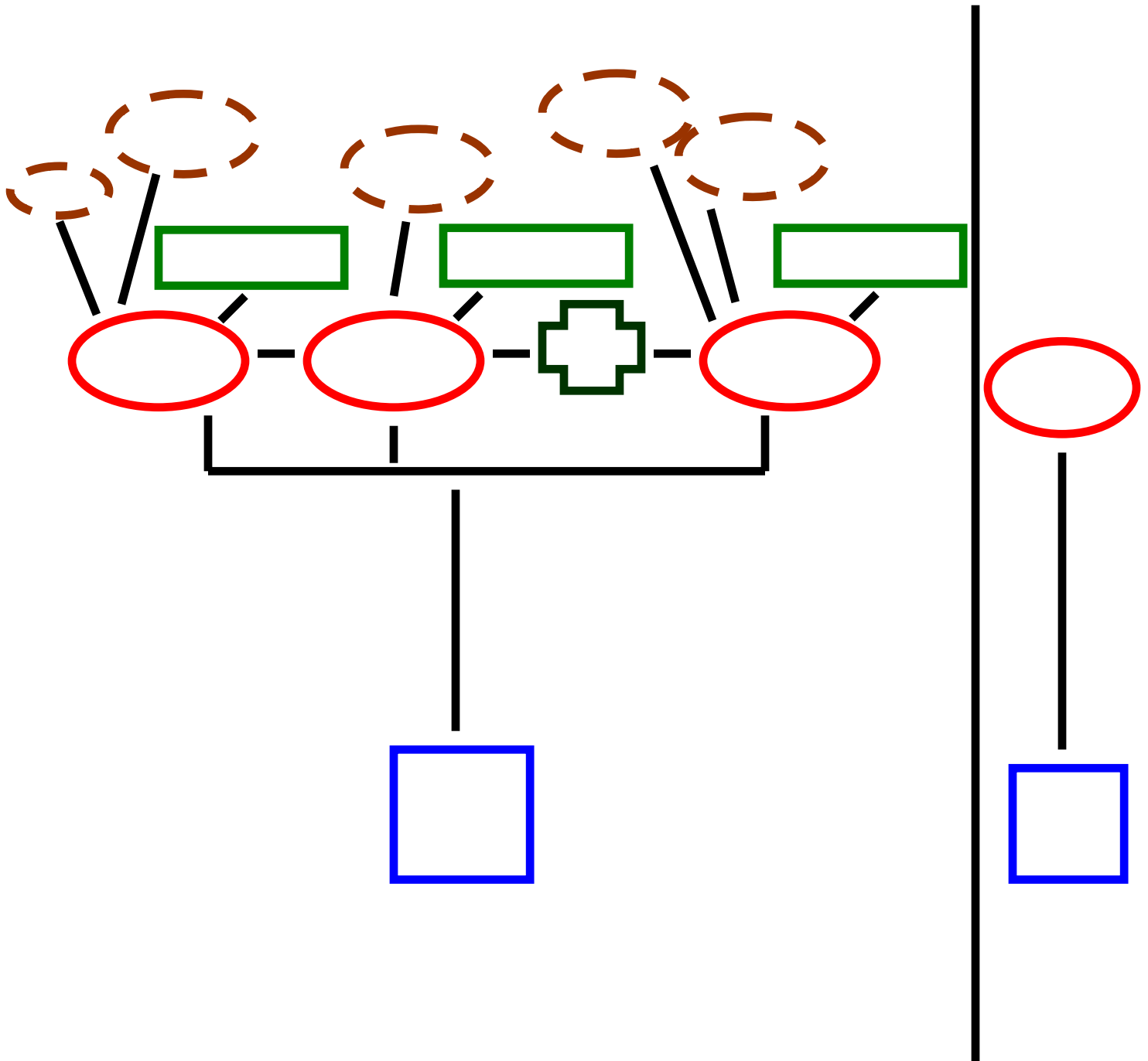

Sometimes, I need to talk about myself...

This is a simple sentence using only my name and an action verb...

In second sentence, the pronoun “I” takes the place of my name.

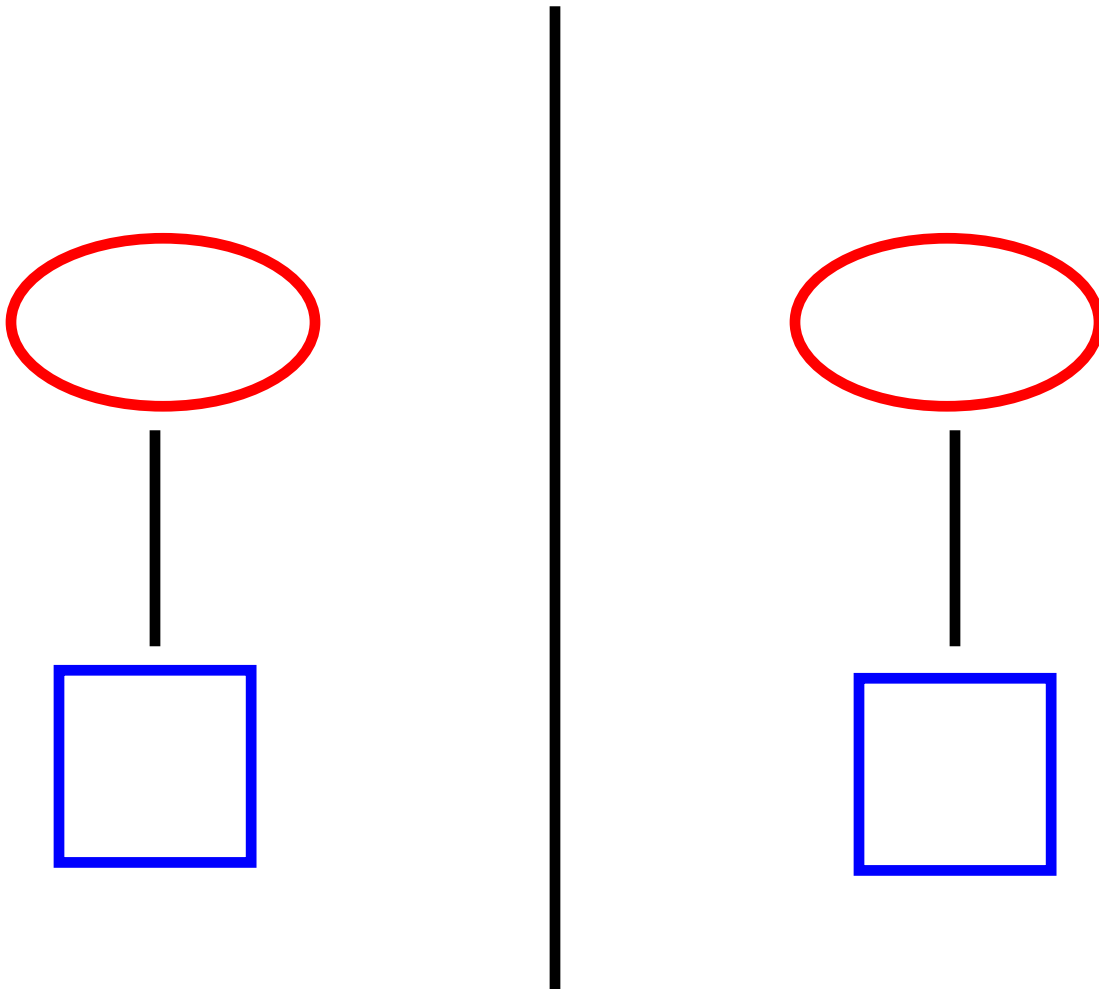

Now, I will add another person to my sentence...

I will still include my name as one of the subjects in the first sentence...

In sentence 2, a pronoun takes the place of my name.

In sentence 3, a pronoun takes the place of both names.

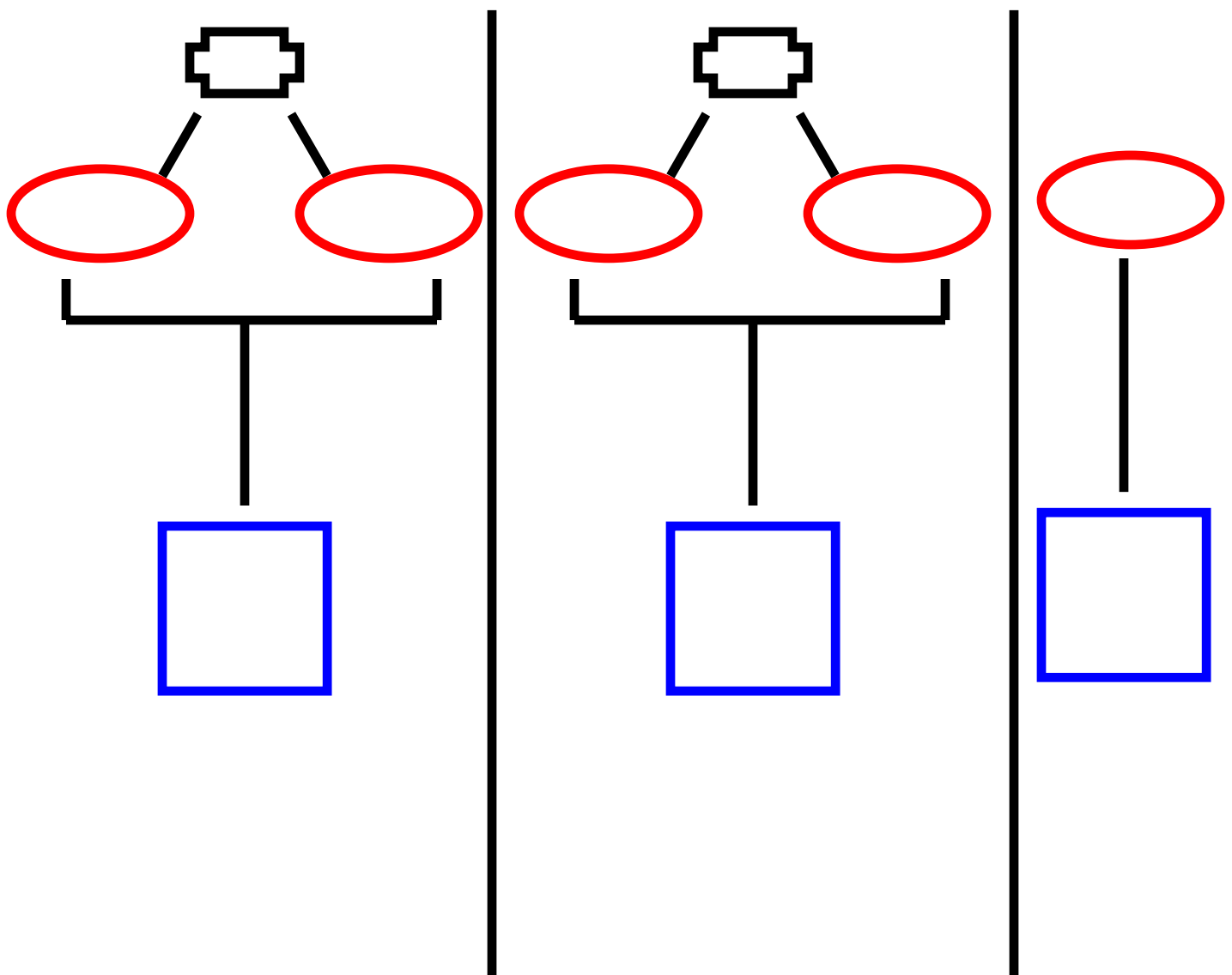

**Now, I will add another person to my sentence...
I will still include my name as one of the subjects in
the first sentence...**

**In sentence 2, I replace my name with a pronoun.
In sentence 3 I replace all names with a pronoun.**

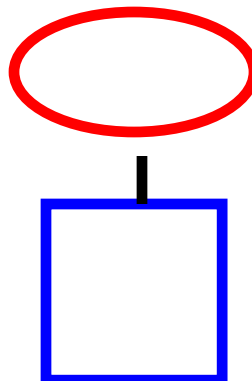
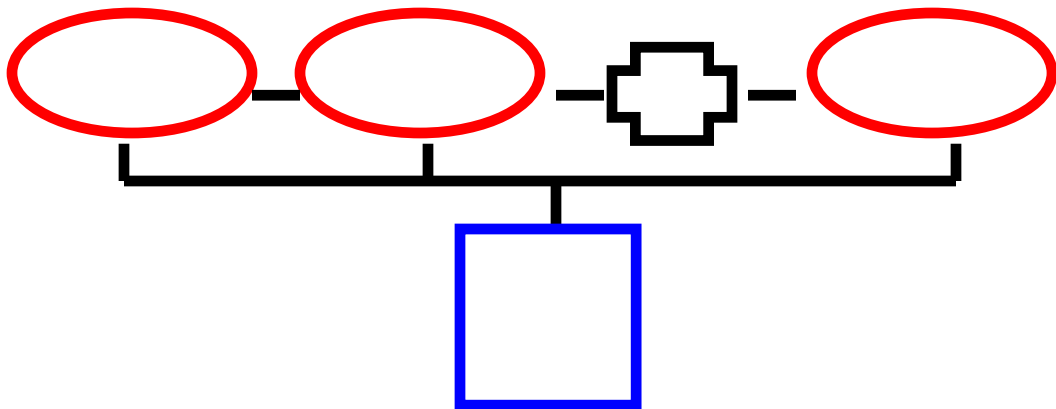
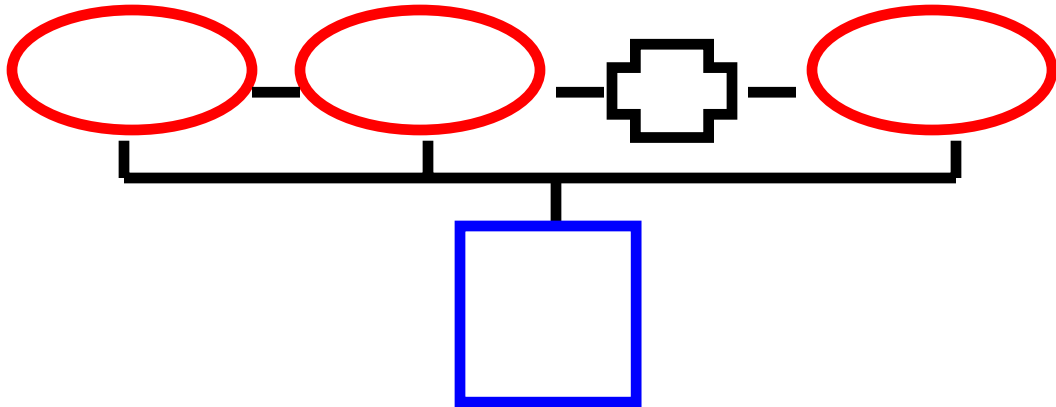

**It is easy to see why people
like to use pronouns when
they talk...**

**Knowing how to use pronouns
allows me to use less words
when talking...this makes
talking a lot easier!**

Remember:

person talking = I = me

person listening = you

**Now, I can see what happens
when I add more information
to the **verb** part of the
sentence...**

Remember:
A **verb is usually an “**action**”
word.**

The **verb tense** tells me “**when**” the action takes place...

Verb tenses:

present = action is being done now

past = action is already finished
= yesterday

future = action has not started yet =
doing it soon or later on

I can make a simple sentence with just one verb...

I will use my name as the subject...and then, I will write the same sentence using a pronoun to take the place of my name in the subject information...

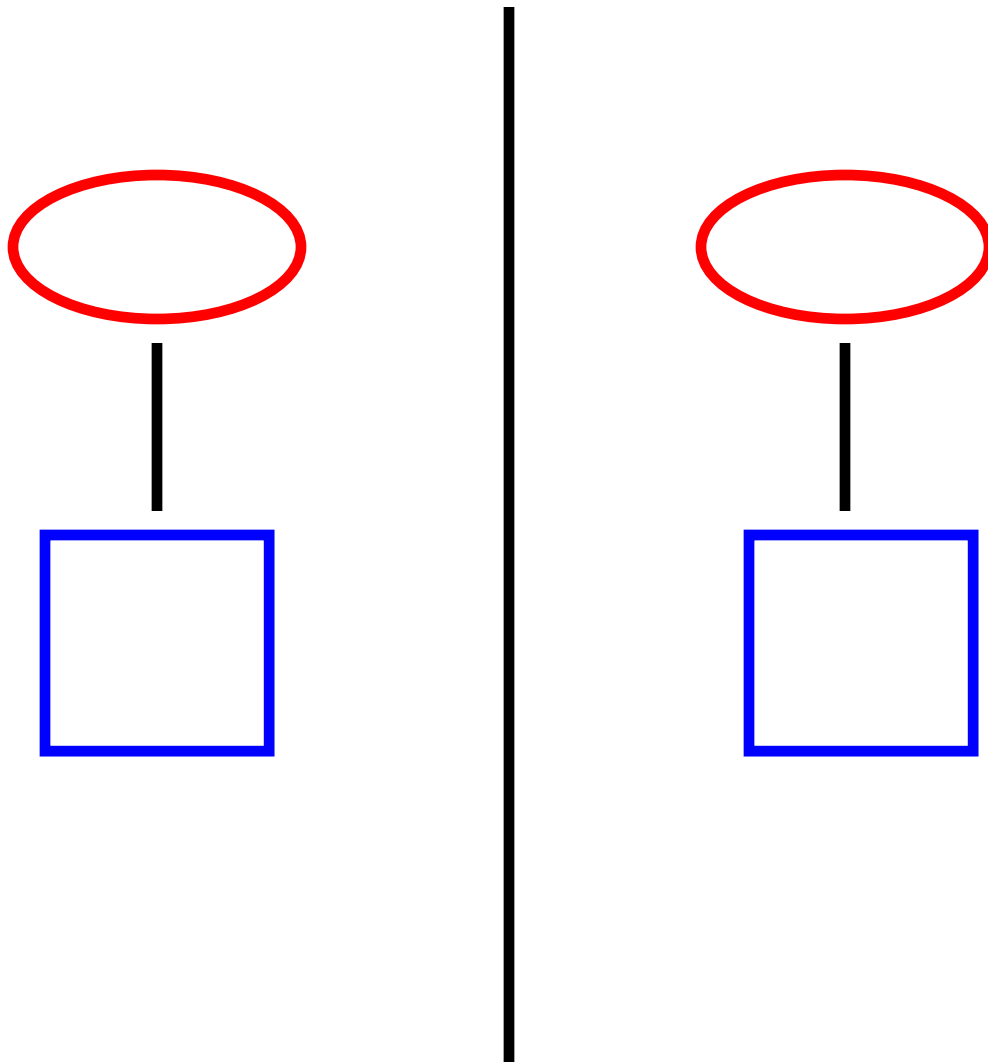

I can make a simple sentence with just one article, one subject and one verb...

I will then use a pronoun to replace the subject information...

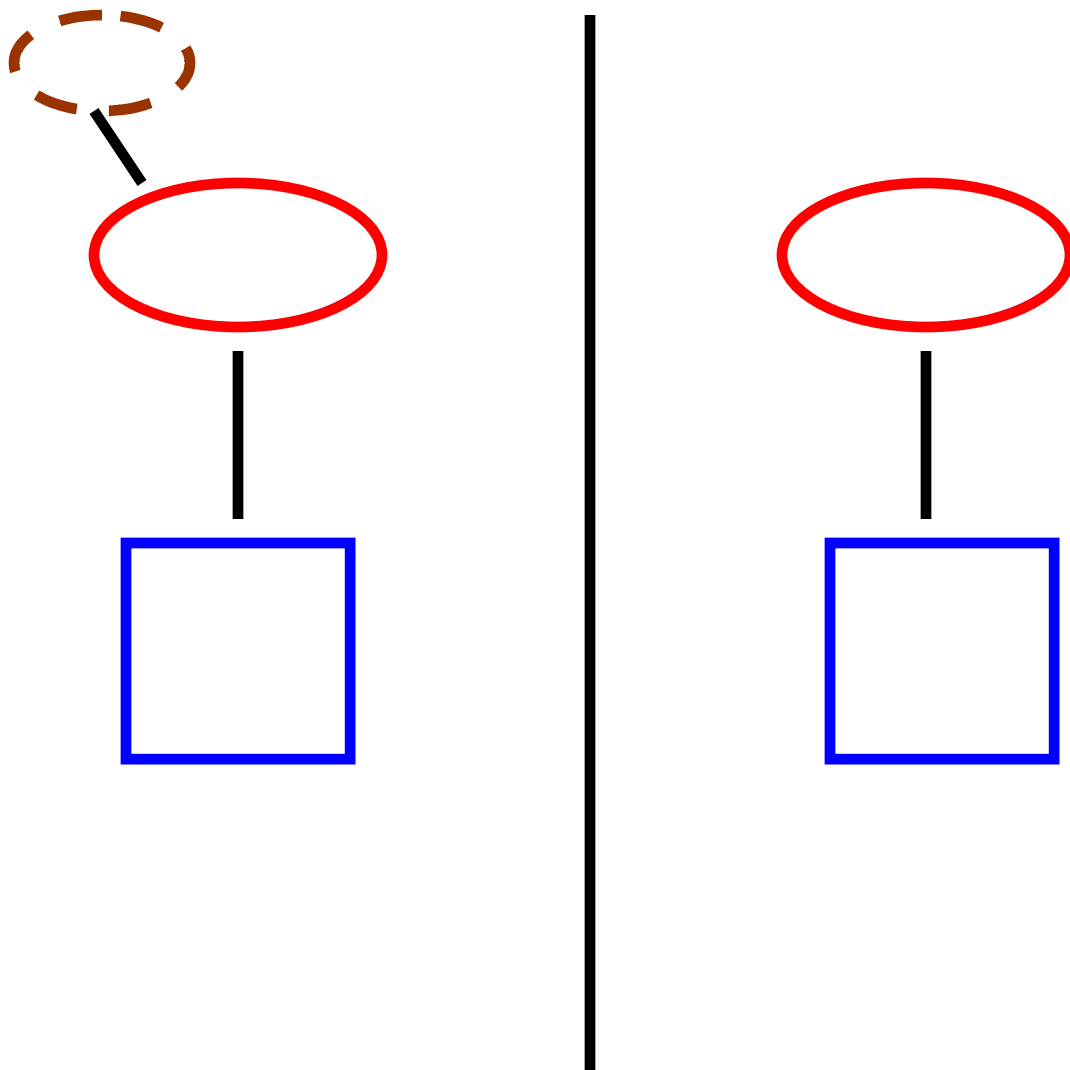

I will write a sentence with two verbs joined by a conjunction...

In this sentence, I will use my name as the subject...

Then, I will write the same sentence using a pronoun to replace the subject...

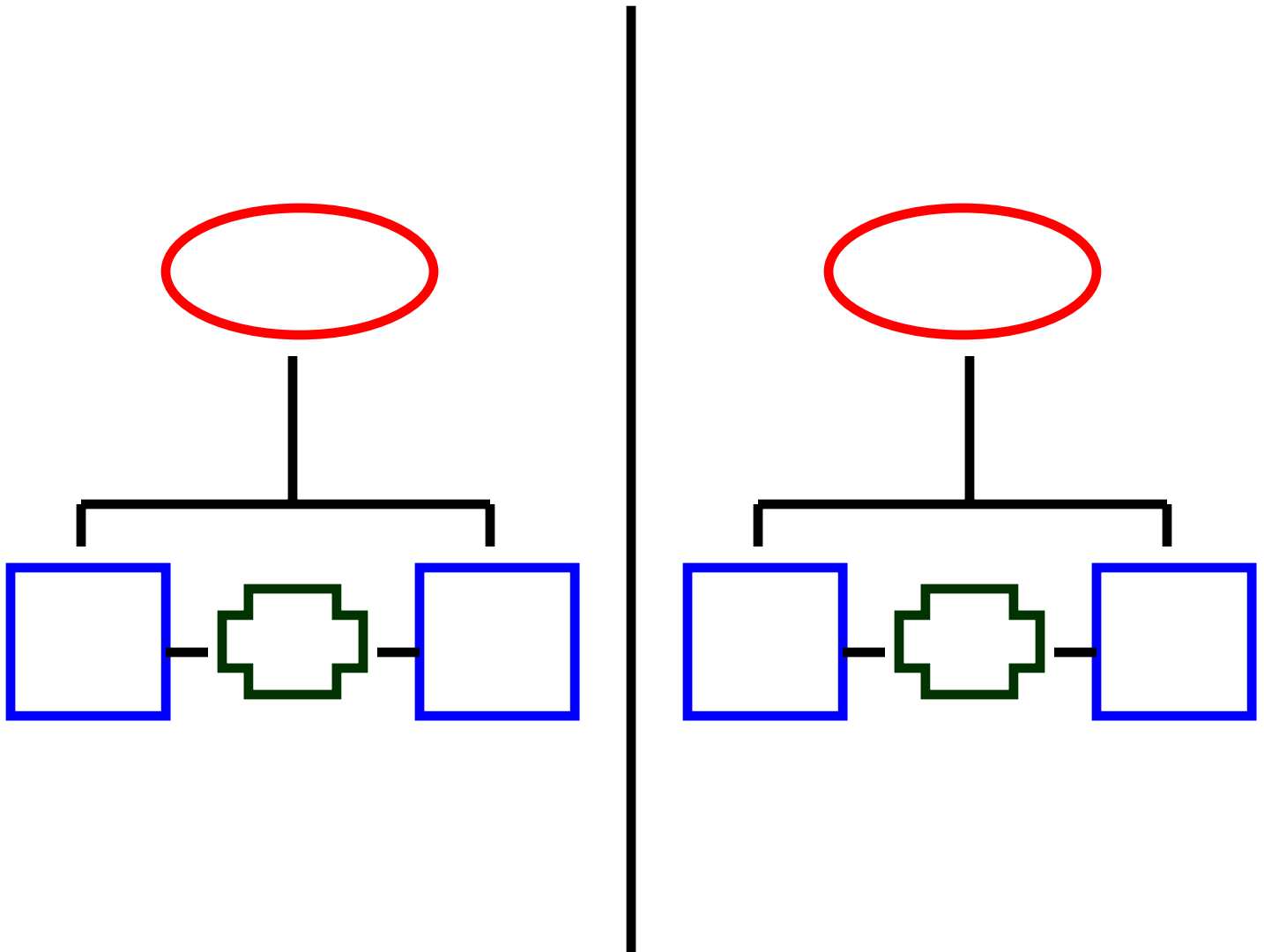

I will write a sentence with one subject, one article and two verbs joined by a conjunction...

Then, I will write the same sentence using a pronoun to replace the subject...

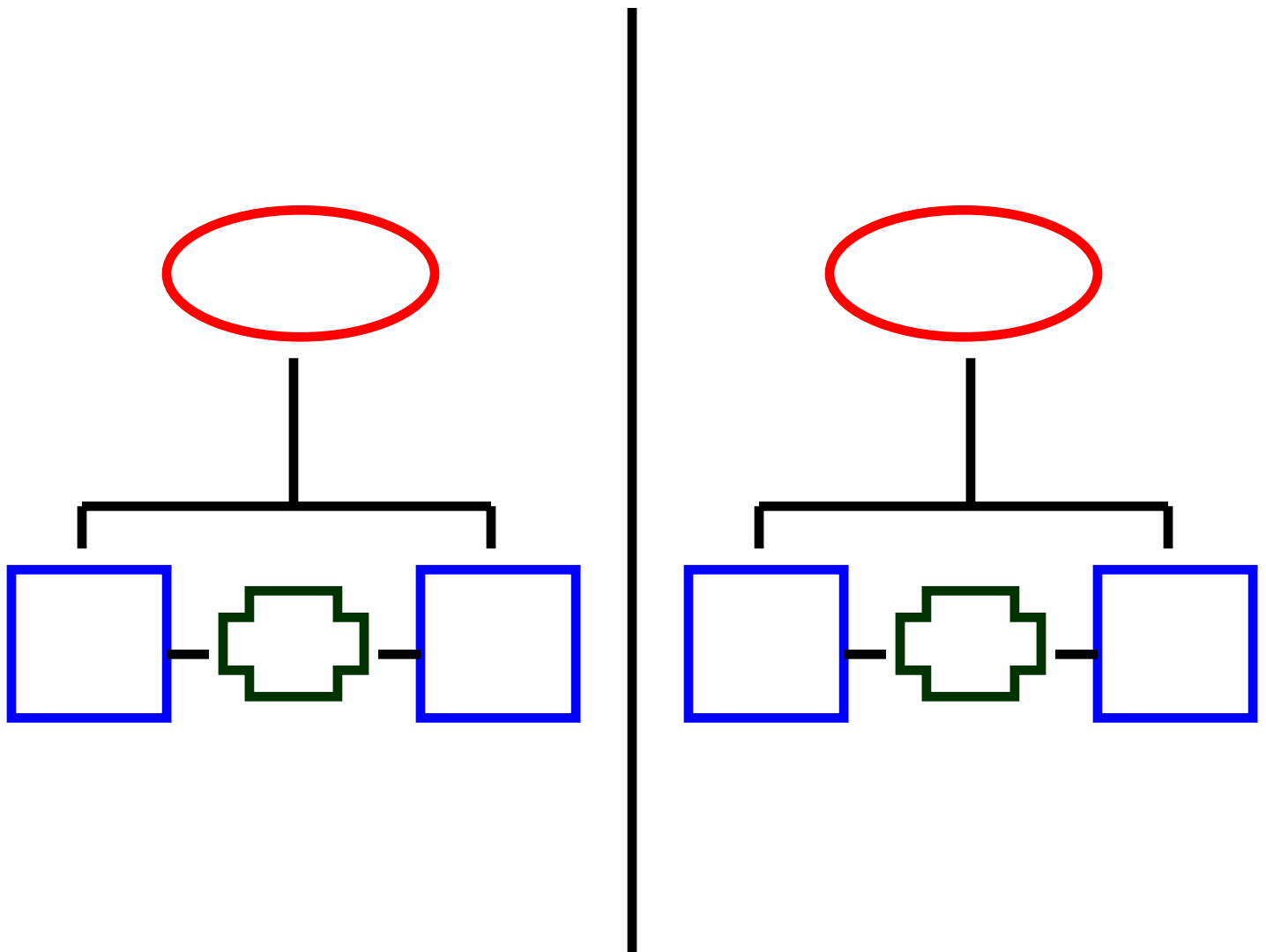

I will write a sentence with two subjects joined by a conjunction and two verbs joined by a conjunction...

I will write the same sentence using pronouns...

I can see that one pronoun takes the place of all the subject information, but the verb information stays the same in both sentences.

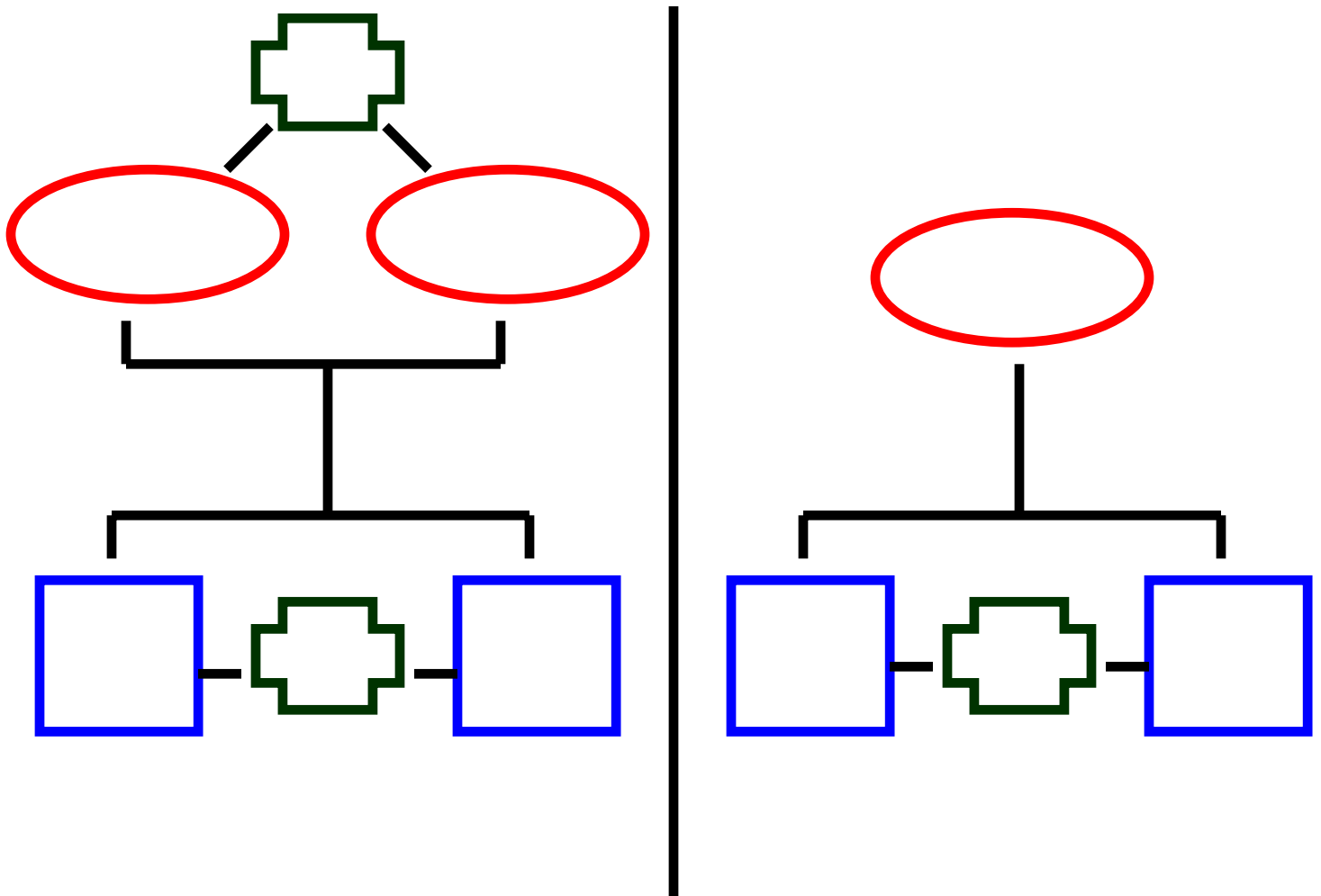

I will write a sentence with two subjects joined by a conjunction and include adjectives and articles as well as two verbs joined by a conjunction...

Then, I will write the same sentence using a pronoun to take the place of the subject information...

Again, I can see that one pronoun can take the place of all the subject information, but... the verb information stays the same...

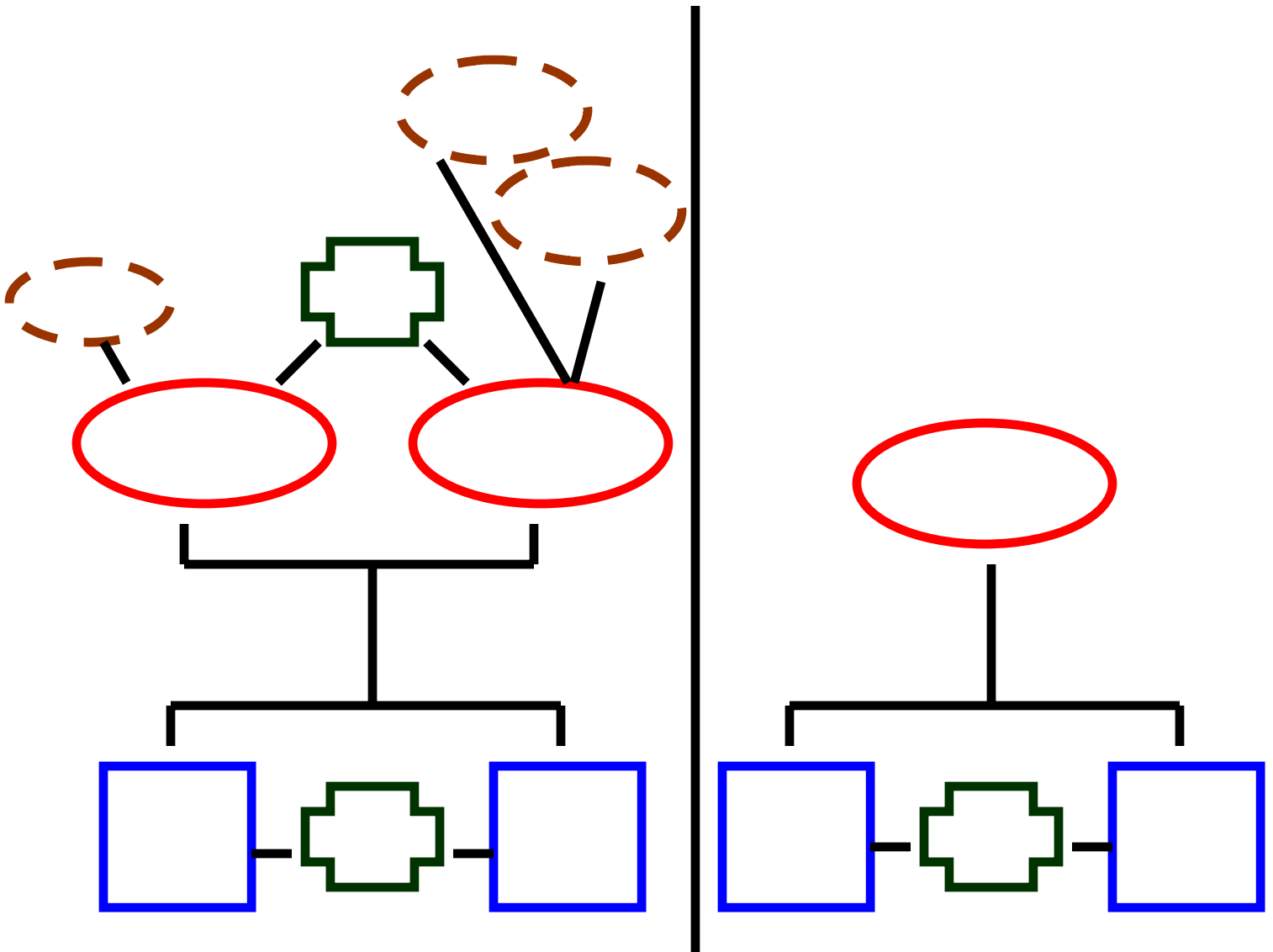

I will write a sentence with two subjects joined by a conjunction that includes some articles and adjectives in the subject information and two verbs and some adverbs for the verb information...

Then, I will write the same sentence using a pronoun to take the place of the subject information...

Again, I can see how just one pronoun can take the place of all the subject information, but...
the verb information stays the same...

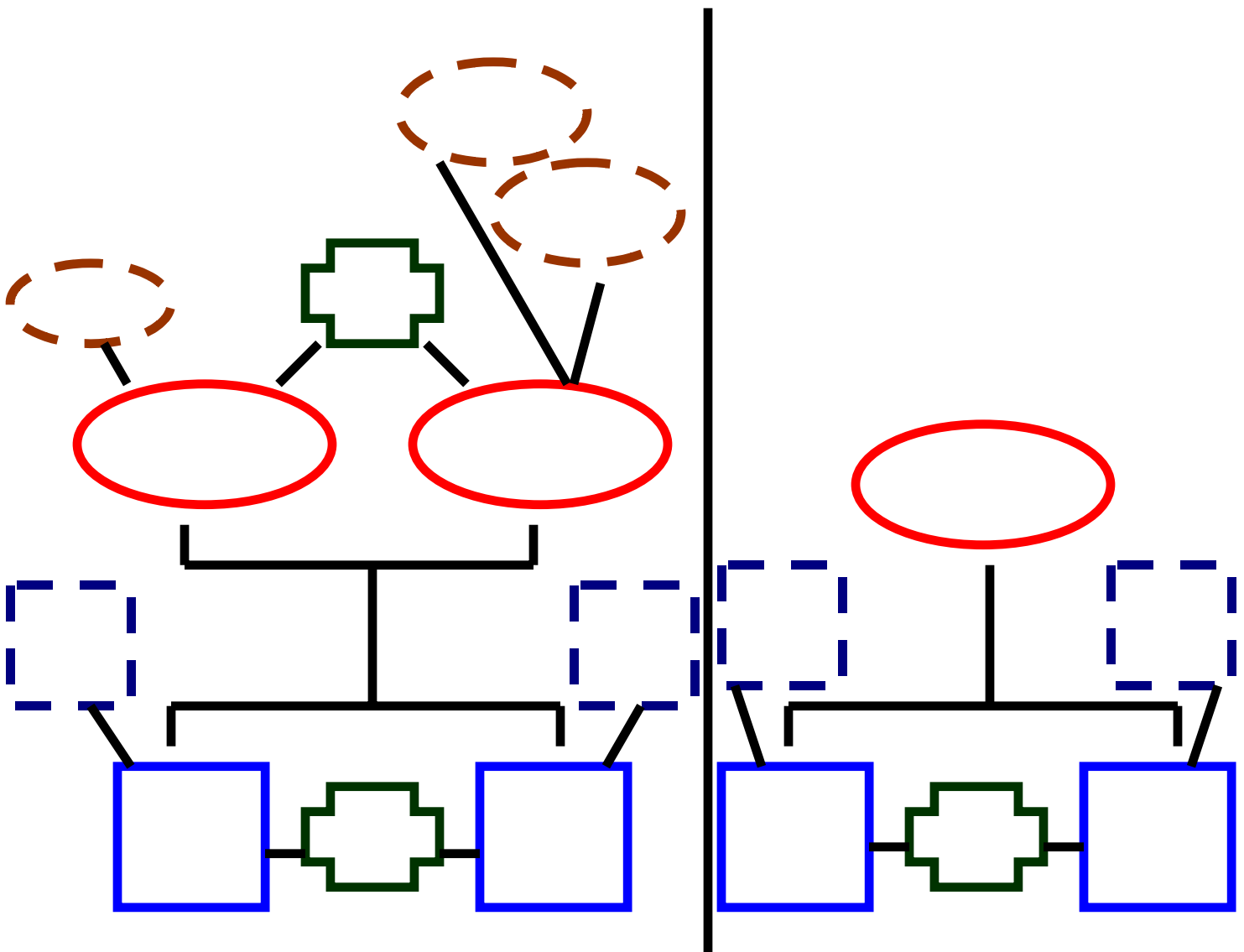

I will write a sentence with two subjects that includes some articles and adjectives where the subjects are joined by a conjunction. My sentence will also have two verbs as well as some adverbs and prepositions for the verb information ...

I will then, write the same sentence using a pronoun to take the place of the subject information... Again, I see how one pronoun can take the place of all the subject information, but the verb information stays the same...

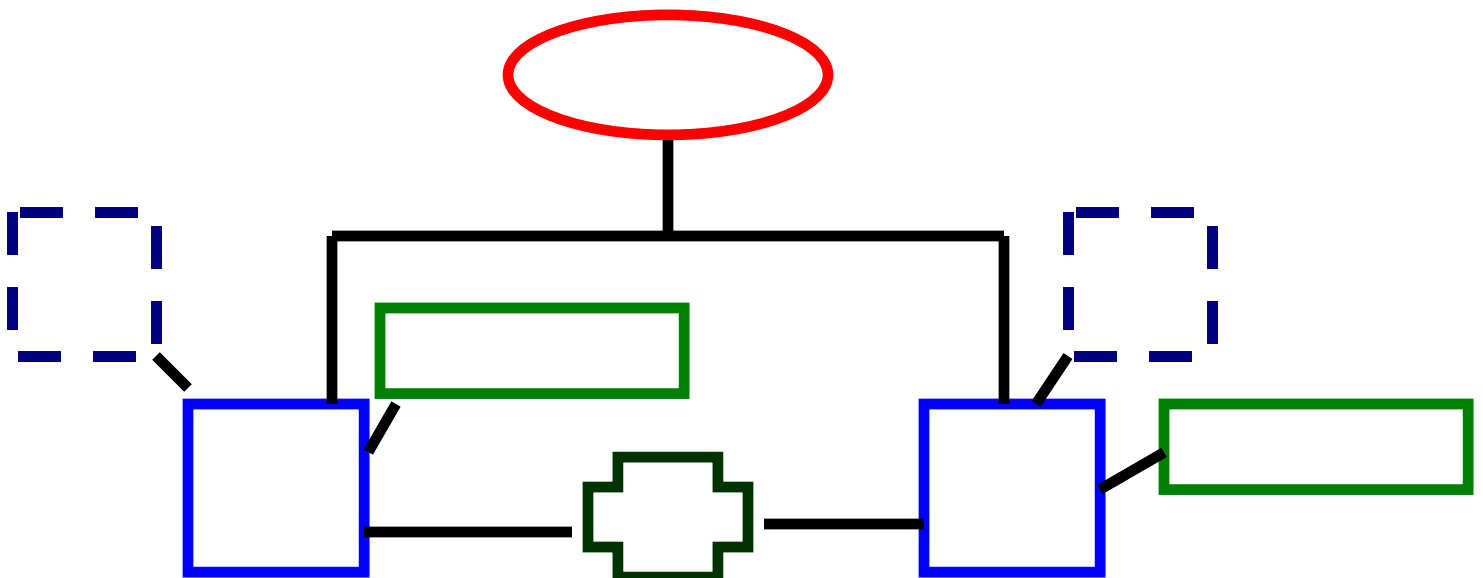
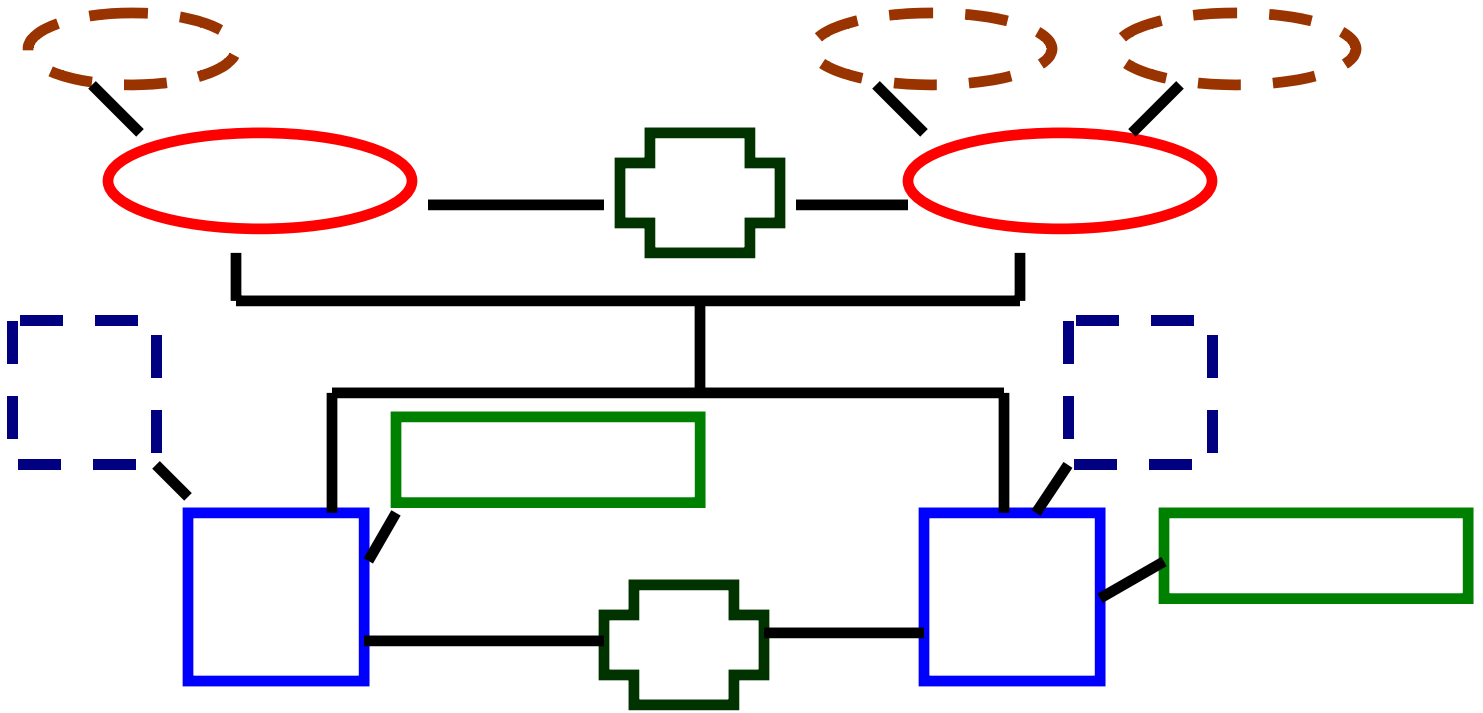

If **ALL the subjects** are **doing ALL the actions**, then, **one pronoun** can replace all the **subject information...**

But, **the verb information stays the same...** I still have to show or say **all of it!**

There are times when **one subject is doing one action** and **the other subject is doing another action....**

Remember:

The **subject** is the train sentence **conductor** = **who** or **what** is doing the action, so, if different people or things are doing different actions, it is like having two conductors doing different things at the same time...

I will now see what happens in that situation...

**I will write a sentence with two subjects and two verbs
but where the subjects are doing different things... I
will use my name as one of the subjects...**

I will then write the same sentence using pronouns...

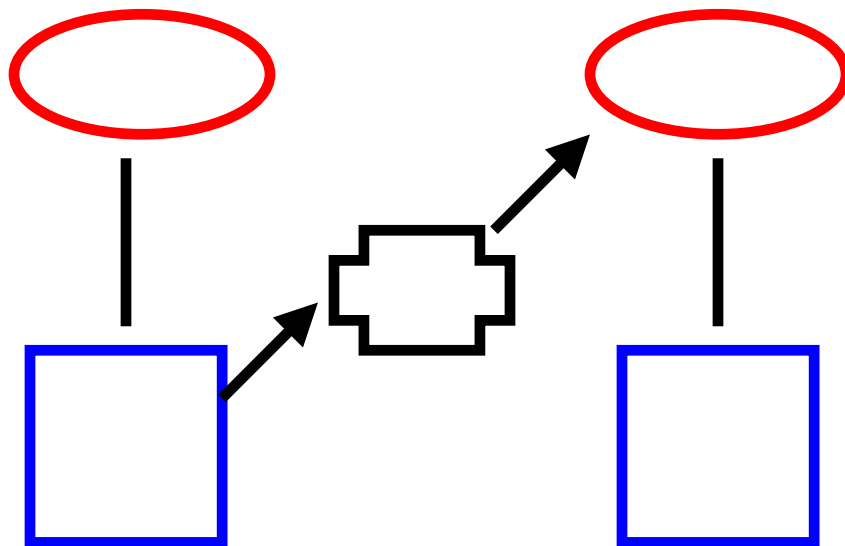
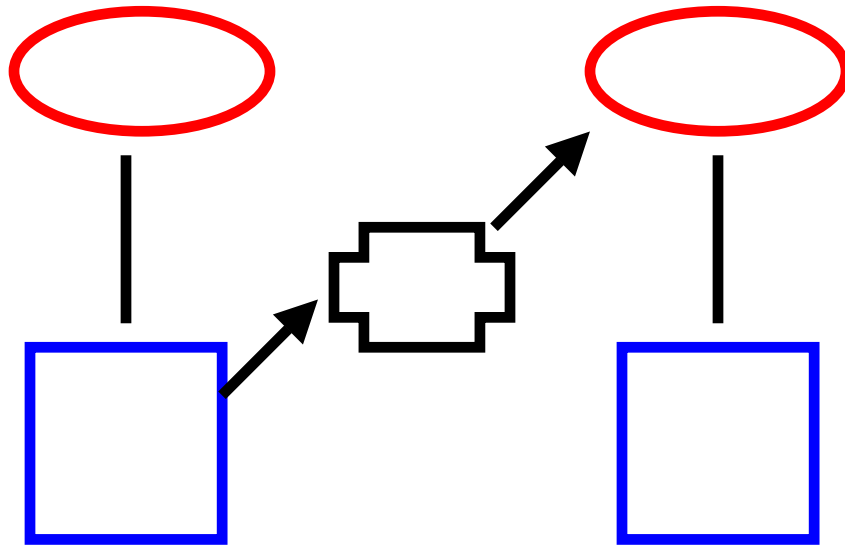

**I will write a sentence with two subjects and two verbs
but where the subjects are doing different things...
My sentence will include articles and adjectives...**

I will then write the same sentence using pronouns...

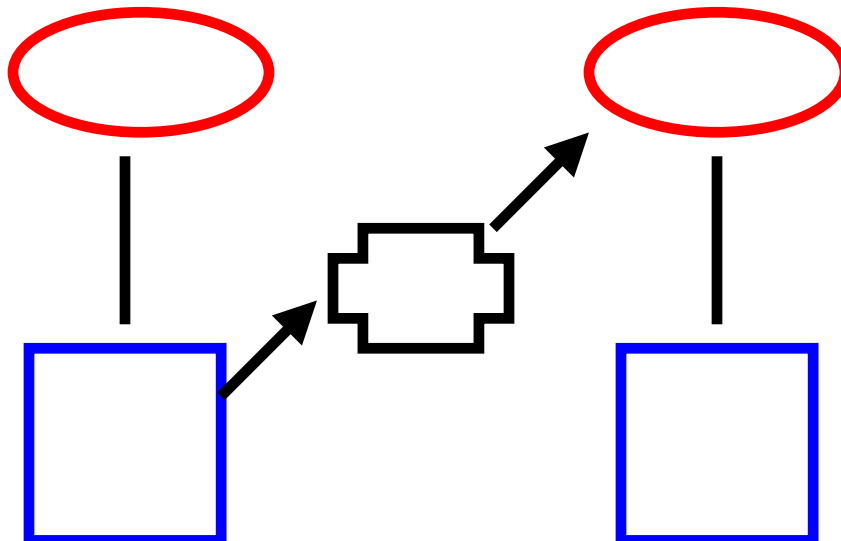
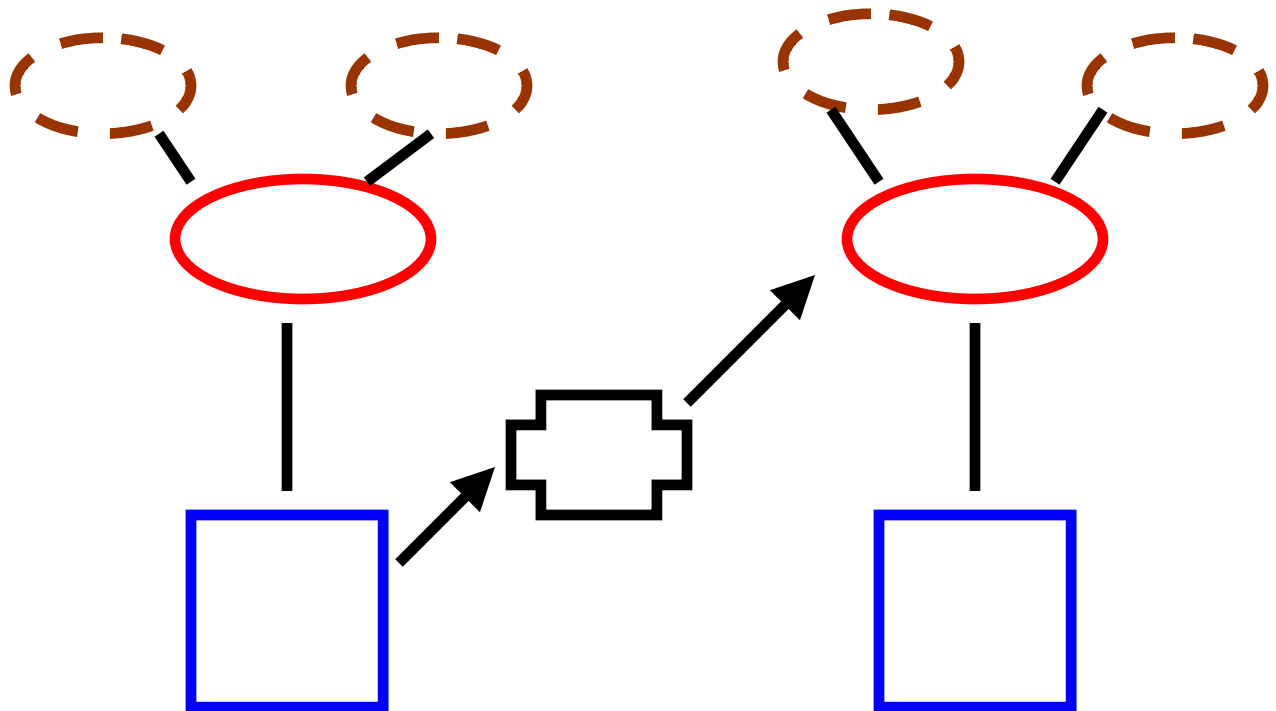

When there is more than one subject and the subjects are doing different things, it is as though I have one sentence train for each activity and its subject(s).

So, I just write the sentence as though it was “different sentences” for each activity and its subject(s) and join them with a **conjunction or “**joining word**”.**

Remember: There are many, many conjunctions or “joining words” ... and so, I can make many, many different sentences.

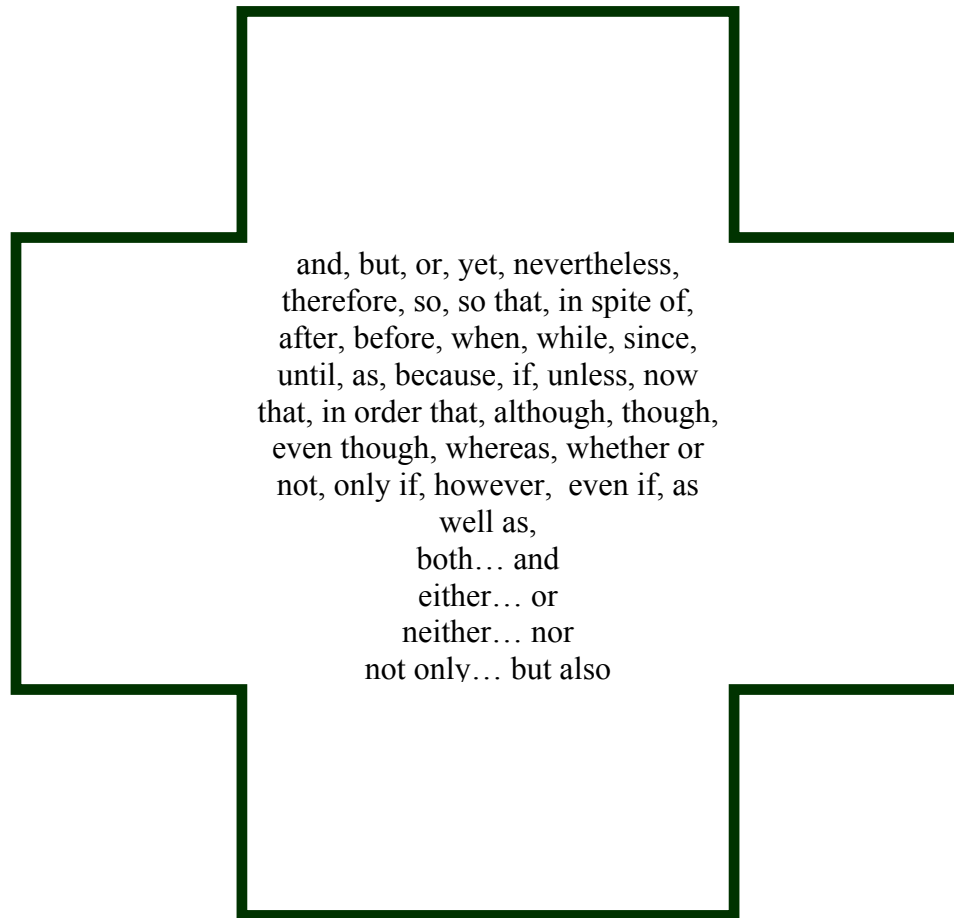

I will write another sentence where the subjects are doing different things...

I will then write the same sentence using pronouns...

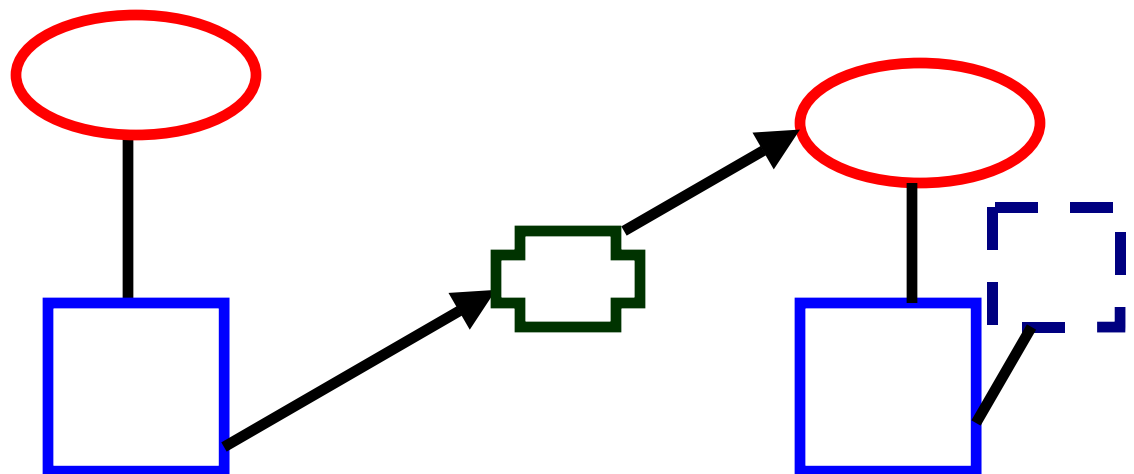
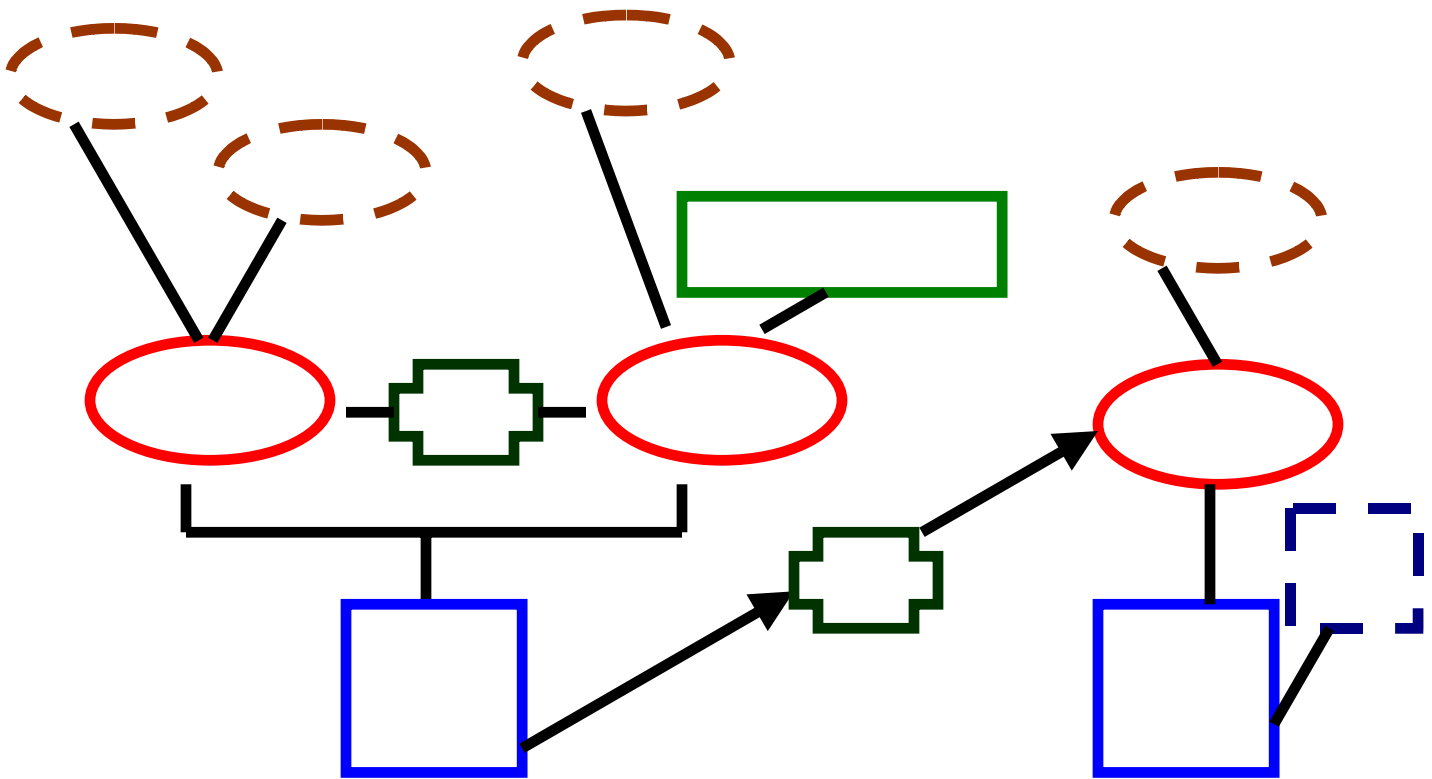

I will write a sentence with **two subjects doing different things...** and add in an **object of the verb.**

Then, I will write the same sentence using **pronouns** to replace **the subject** and **the object of the verb.**

Remember: The **object of the verb** is who or what the **action** is being “**done to**”.

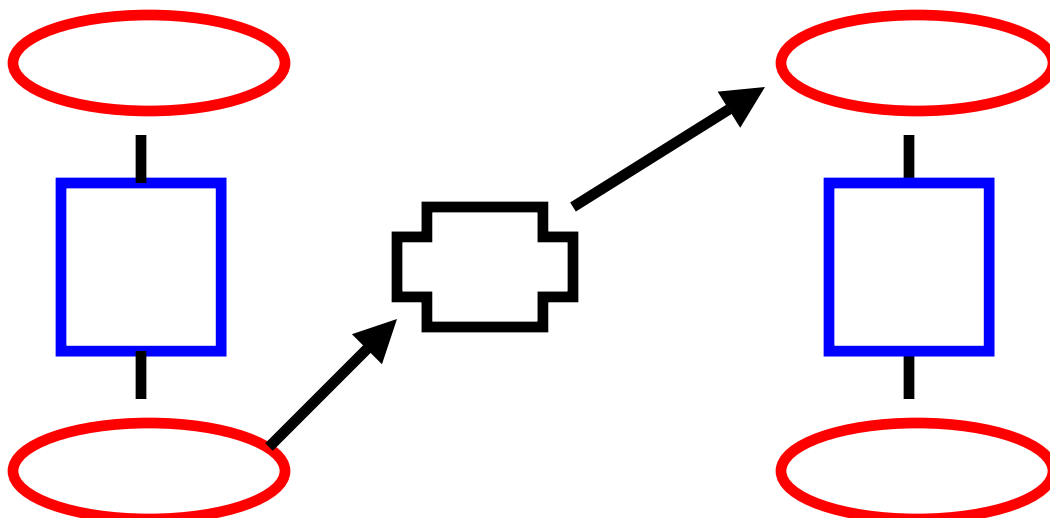
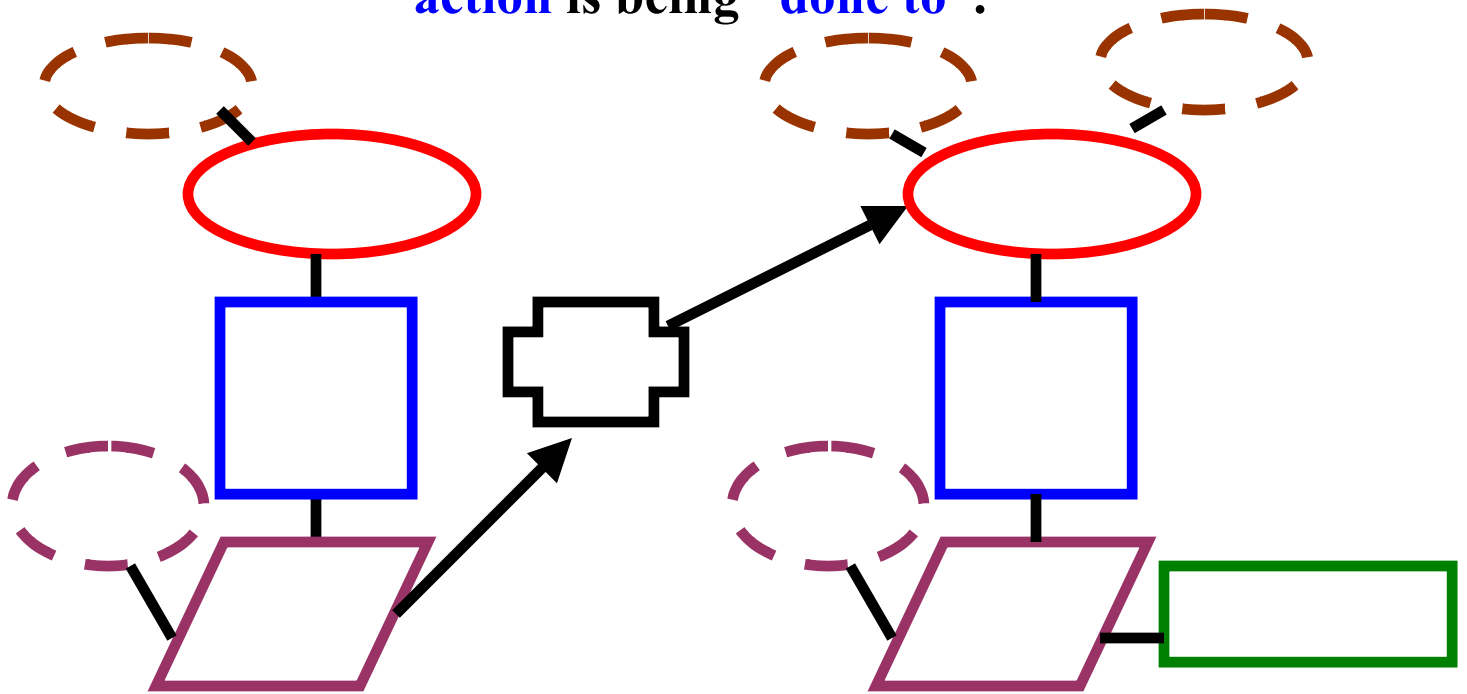

I will write a sentence with just one subject and one verb but two objects of the verb that are joined by a conjunction...

I will use my name as the subject...

I will then write the same sentence using pronouns to replace my name and the object of the verb...

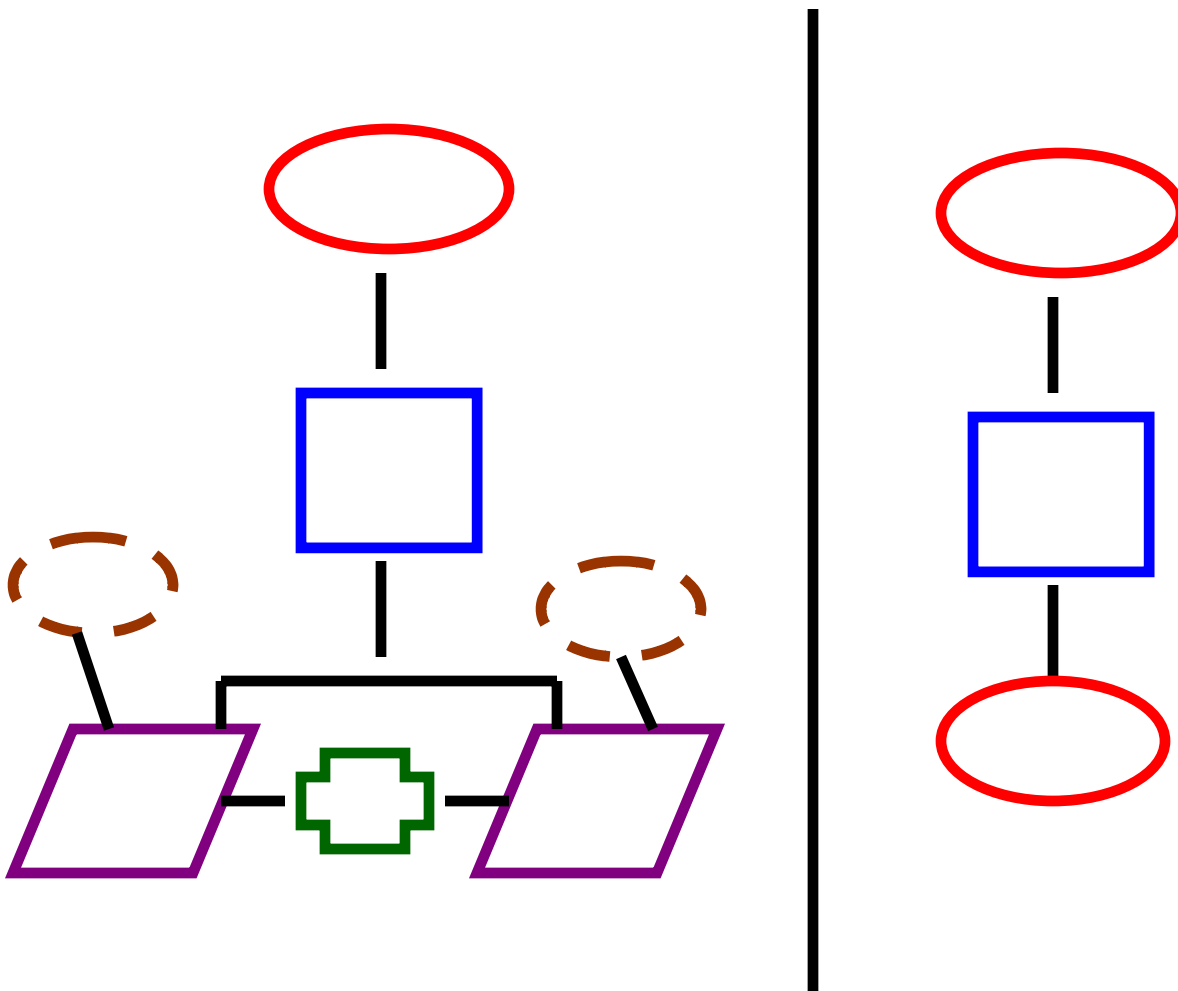

I will write a sentence with just one subject and one verb but two objects of the verb that are joined by a conjunction...

I will then write the same sentence using pronouns to replace the subject and the object of the verb...

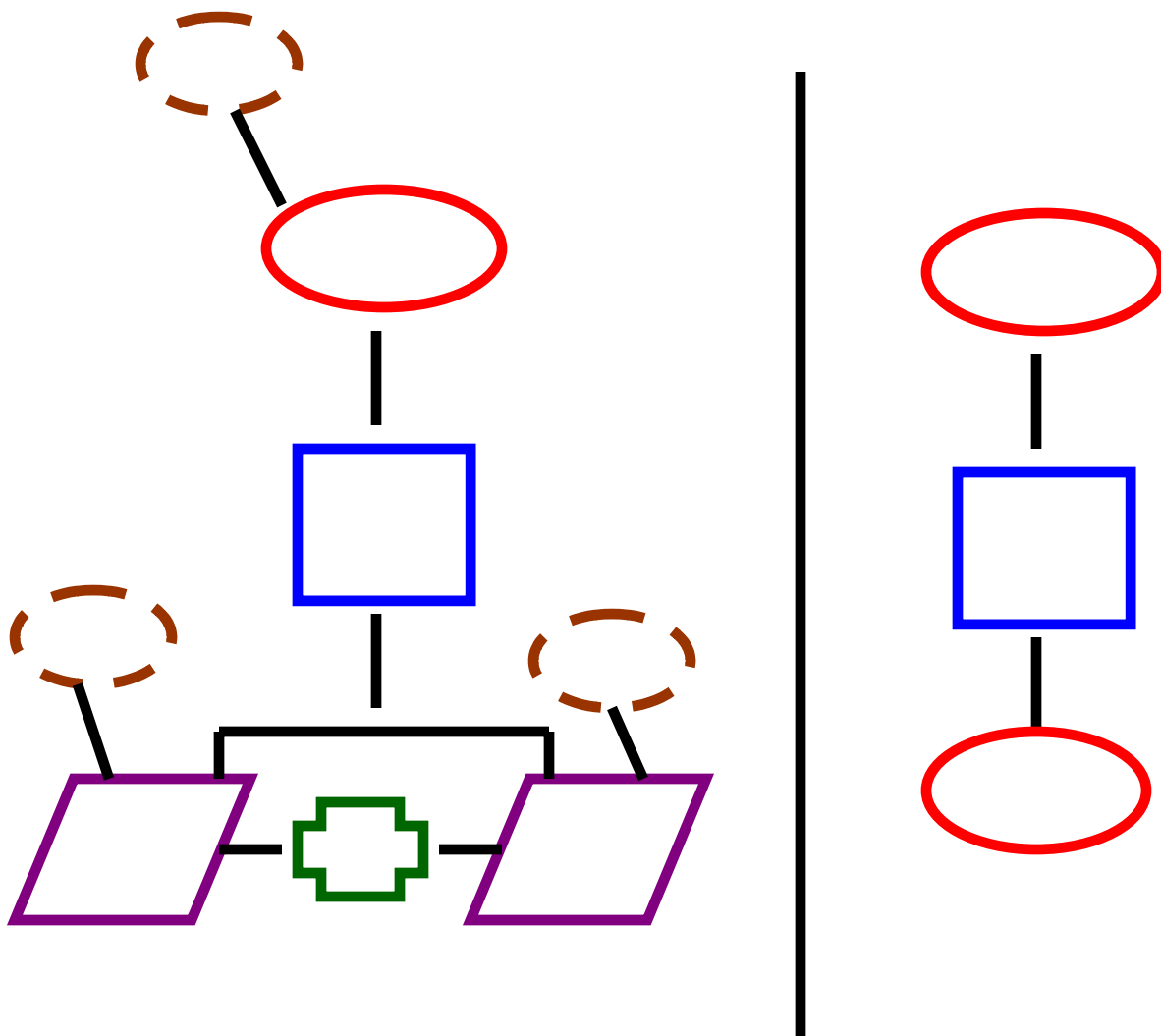

**I can see, there are many, many sentences I can make
whether I am writing or talking.**

**The key to talking is just to know what I want to say
and what words I want to include in my sentence.**

**Once I know how to make a sentence, it is very easy to
write or, to talk.**

**“Conversation” or “talking” is very much like
writing... the only difference is that when I talk, I use
my mouth instead of a pencil and paper.**

**I know the person talking and the person listening
“take turns” being “the conductor”... so, when
someone else is talking, I need to listen.**

**Talking is the fastest way to communicate... and that
is why people use talking the most when they interact.**

To talk... all I really need to do is join many sentence trains together...

That is also how I write a story. I just put together sentence trains that are about “something”.

**Now that I have practiced
making sentences, I can figure
out how to draw sentences
someone gives me...**

**If I like, I can simply put the
right shape around each
word... just to make it easier.**

**The next page(s) have practice
sentences that I can draw...**

Run!

Walk and listen!

I have a cat.

My mommy and daddy are wonderful.

I swam in the lake.

I ate pretzels.

Mom and I are playing.

We like car rides.

The little dog, the fat cat and the rabbit were in the yard.

My friend is coming soon.

I went down the slide quickly but carefully.

I drew a big, fast, red rollercoaster and a tall and slow Ferris wheel.

She plays the piano.

Our kite went high in the sky.

The strong wind blew it away.

It landed in a tree.

He climbed the tree to get his kite.

The bees made a hive in our maple tree.

Bears sleep during the winter.

Playing on the computer is fun.

He slept while we went shopping.

Close the door.

The acorn fell from the oak tree.

I tied my shoelaces tightly.

Learning is fun.

It is easy to fix mistakes.

Everyone makes some mistakes at first.

I can simply try again.

I can ask for help when I need it.

Help!

This is easy.

Mom can teach me things.

Talking is like a puzzle.

You simply put pieces in place.

I love my family.

My family loves me.

I am happy.

It is a beautiful day.

Great job!

Wow!

My heart is full of joy.

I understand now.

I love talking with mom.



Note To Parents...

I encourage you to graph your child's speech and hope that together, you will come up with many, many more sentence trains.

I provided what I saw as "the basics" to teach Zachary this concept... but, obviously, the possibilities are endless... :o)

End of materials

**This work, I give to you for the glory of
my Lord and Savior, Jesus Christ.**